



ÜRÜN KATALOGU
PRODUCT CATALOG

2024-2025

DEĞERLERİMİZ | OUR VALUES

MÜŞTERİ ODAKLILIK
CUSTOMER FOCUS



YENİLİKÇİLİK, DEĞİŞİME UYUM
INNOVATION, ADAPTING TO CHANGE



ETİK İLKELER, DÜRÜSTLÜK, ŞEFFAFLIK
ETHICAL PRINCIPLES, HONESTY, TRANSPARENCY



İNSANA VE TOPLUMA SAYGI
RESPECT FOR PEOPLE AND SOCIETY



ÇEVREYE VE DÜNYAYA SAYGI
RESPECT FOR THE ENVIRONMENT AND THE WORLD



KALİTE BELGELERİMİZ | QUALITY CERTIFICATES

HAKKIMIZDA | ABOUT US



Firmamız **Mısır GOEIC**
İhracat Sistemine
Kayıtlıdır.

*Our Company Has Registration
For Export To Egypt
According To GOEIC System.*



1969 yılında **Mahmut ÖZER** tarafından kurulan, 55 yılı aşkın tecrübeye sahip, plastik ev gereçleri üreten köklü bir firma olan **ÖZ-ER PLASTİK**, uluslararası ve ulusal arenada istikrarlı ve güvenilir bir firma olarak tanınmaktadır.

İstanbul'da **13.000 m²** kapalı alanda üretimini gerçekleştiren firma ürün yelpazesine inovatif ürünler eklemekte olup, sürekli gelişen üretim gücü, yüksek itibarlı markası, üstün ürün kalitesi ve değer yaratan sürdürülebilir büyüme yaklaşımıyla büyük atılımlar gerçekleştirmektedir.

Founded in 1969 by **Mahmut ÖZER**, **ÖZ-ER PLASTİK**, a well-established company producing plastic household appliances with over **55** years of experience, is recognized as a stable and reliable company in the international and national arena.

The company, which carries out its production in a **13.000 m²** closed area in Istanbul, adds innovative products to its product range and makes great strides with its constantly developing production power, highly reputable brand, superior product quality and sustainable growth approach that creates value.



iÇİNDEKİLER | INDEX

08-25
BANYO AKSESUARLARI | BATHROOM ACCESSORIES

26-63
GENEL KULLANIM | GENERAL USAGE

64-73
TEMİZLİK GRUBU | CLEANING ACCESSORIES

74-91
MUTFAK ÜRÜNLERİ | KITCHEN PRODUCTS

92-106
BEBEK-ÇOCUK ÜRÜNLERİ | BABY-CHILD ACCESSORIES



BANYO AKSESUARLARI BATHROOM ACCESSORIES

ESTETİK ve KOLAYLIK
AESTHETIC and CONVENIENCE

01

DALGALI BANYO SERİSİ

WAVY EMBOSS BATHROOM COLLECTION



DL009

NEW



DESIGN CODE : X 86 | SIYAH | BLACK



DESIGN CODE : X 38 | GRİ | GRAY



DESIGN CODE : X 24 | BEYAZ | WHITE



DESIGN CODE : X 161 | KUM BEJİ | SAND BEIGE

WAVY EMBOSS
BATHROOM COLLECTION

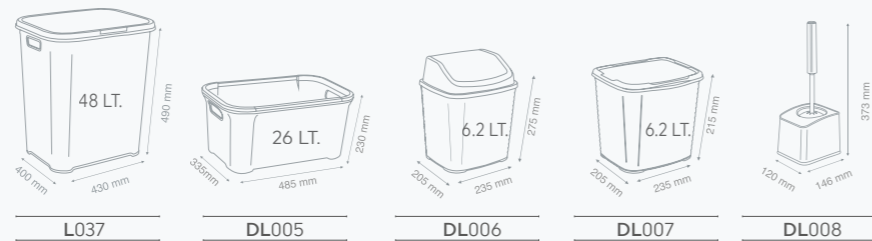

5 prç. DALGALI BANYO SETİ | WAVY BATH SET 5 pcs

ÜRÜN KODU PRODUCT CODE	ÜRÜN ADI AÇIKLAMA PRODUCT NAME	KAPASİTE CAPACITY LT.	TEK ÜRÜN AĞIRLIĞI PRODUCT WEIGHT	KOLİ İÇİ ADET PCS IN BOX	KOLİ NET NET WEIGHT	KOLİ BRÜT GROSS W.	KOLİ EBATİ BOX DIMENSIONS (MM)	KOLİ m ³ BOX m ³	AMBALAJ ŞEKLİ PACKING TYPE	BARKOD EAN 13 CODE
DL009	DALGALI BANYO SETİ 5 prç. / WAVY BATH SET 5 pcs	-	2,85	1 SET	2,85	3,75	505 x 380 x 505	0,095	BOX	8697422308085

DALGALI BANYO ÜRÜNLERİ

WAVY BATHROOM PRODUCTS

L037.

NEW

48 LT



DESIGN CODE : X 86 | SİYAH | BLACK



DESIGN CODE : X 38 | GRİ | GRAY



DESIGN CODE : X 161 | KUM BEJİ | SAND BEIGE



DESIGN CODE : X 24 | BEYAZ | WHITE

DL005.

26 LT



DESIGN CODE : X 86 | SİYAH | BLACK



DESIGN CODE : X 38 | GRİ | GRAY



DESIGN CODE : X 161 | KUM BEJİ | SAND BEIGE



DESIGN CODE : X 24 | BEYAZ | WHITE



DL007.

NEW

6.2 LT



DESIGN CODE : X 86 | SİYAH | BLACK



DESIGN CODE : X 38 | GRİ | GRAY



DESIGN CODE : X 161 | KUM BEJİ | SAND BEIGE



DESIGN CODE : X 24 | BEYAZ | WHITE

DL006.

6.2 LT



DESIGN CODE : X 86 | SİYAH | BLACK



DESIGN CODE : X 38 | GRİ | GRAY



DESIGN CODE : X 161 | KUM BEJİ | SAND BEIGE



DESIGN CODE : X 24 | BEYAZ | WHITE

DL008.



DESIGN CODE : X 86 | SİYAH | BLACK



DESIGN CODE : X 38 | GRİ | GRAY



DESIGN CODE : X 161 | KUM BEJİ | SAND BEIGE



DESIGN CODE : X 24 | BEYAZ | WHITE

DALGALI BANYO ÜRÜNLERİ | WAVY BATHROOM PRODUCTS

ÜRÜN KODU PRODUCT CODE	ÜRÜN ADI AÇIKLAMA PRODUCT NAME	KAPASİTE CAPACITY LT.	TEK ÜRÜN AĞIRLIĞI PRODUCT WEIGHT	KOLİ İÇİ ADET PCS IN BOX	KOLİ NET NET WEIGHT	KOLİ BRÜT GROSS W.	KOLİ EBATİ BOX DIMENSIONS (MM)	KOLİ m³ BOX m³	AMBALAJ ŞEKLİ PACKING TYPE	BARKOD EAN 13 CODE
L037	DALGALI KIRLI ÇAMAŞIR SEPETİ ve KAPAK / WAVY LAUNDRY BASKET & COVER	48 LT.	1,52	12	14,64	14,64	335 x 420 x 1415	0,19	BULK	8697422307996
DL005	DALGALI ÇAMAŞIR SEPETİ / WAVY CLOTHES BASKET	26 LT.	0,55	20	11	11,100	339 x 500 x 1131	0,19	POLY BAG	8697422308047

DALGALI BANYO ÜRÜNLERİ | WAVY BATHROOM PRODUCTS

ÜRÜN KODU PRODUCT CODE	ÜRÜN ADI AÇIKLAMA PRODUCT NAME	KAPASİTE CAPACITY LT.	TEK ÜRÜN AĞIRLIĞI PRODUCT WEIGHT	KOLİ İÇİ ADET PCS IN BOX	KOLİ NET NET WEIGHT	KOLİ BRÜT GROSS W.	KOLİ EBATİ BOX DIMENSIONS (MM)	KOLİ m³ BOX m³	AMBALAJ ŞEKLİ PACKING TYPE	BARKOD EAN 13 CODE
DL006	DALGALI KLİK ÇÖP KOVASI / WAVY CLICK BIN	6.2 LT.	0,337	20	6,74	7,35	465 x 390 x 595	0,108	BOX	8697422308054
DL007	DALGALI DETERJANLIK / WAVY DETERGENT BOX	6.2 LT.	0,306	20	6,12	6,73	475 x 415 x 535	0,105	BOX	8697422308061
DL008	DALGALI KÖŞELİ WC FIRÇASI / WAVY RECT. WC BRUSH	-	0,172	24	4,128	4,738	610 x 390 x 410	0,19	BOX	8697422308078

ÇİZGİLİ BANYO ÜRÜNLERİ

LINE BATHROOM PRODUCTS



CZ006

NEW



52 LT

DESIGN CODE : X 86 | SİYAH | BLACK



DESIGN CODE : X 38 | GRİ | GRAY

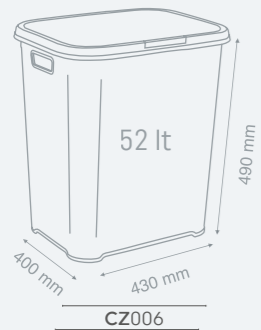

DESIGN CODE : X 24 | BEYAZ | WHITE



DESIGN CODE : X 161 | KUM BEJİ | SAND BEIGE



CZ014

NEW



DESIGN CODE : X 86 | SİYAH | BLACK

CZ015



DESIGN CODE : X 24 | BEYAZ | WHITE



DESIGN CODE : X 161 | KUM BEJİ | SAND BEIGE



DESIGN CODE : X 38 | GRİ | GRAY



CZ015



CZ017



CZ016



CZ015



CZ017



CZ016

ÇİZGİLİ BANYO ÜRÜNLERİ | LINE BATHROOM PRODUCTS

ÜRÜN KODU PRODUCT CODE	ÜRÜN ADI AÇIKLAMA PRODUCT NAME	KAPASİTE CAPACITY LT.	TEK ÜRÜN AĞIRLIĞI PRODUCT WEIGHT	KOLİ İÇİ ADET PCS IN BOX	KOLİ NET NET WEIGHT	KOLİ BRÜT GROSS W.	KOLİ EBATLARI BOX DIMENSIONS (MM)	KOLİ m ³ BOX m ³	AMBALAJ ŞEKLİ PACKING TYPE	BARKOD EAN 13 CODE
CZ006	ÇİZGİLİ KİRLİ SEPETİ / LINE LAUNDRY HAMPER	52 LT.	1,735	12	18,084	18,66	490 x 435 x 1395	0,24	POLY BAG	8697422308139
CZ014	ÇİZGİLİ 3'LÜ BANYO SETİ / LINE 3 PCS. BATHROOM SINK SET	-	0,185	24	4,46	5,1	513 x 455 x 300	0,07	VACUUM BAG+BOX	8697422308269
CZ015	ÇİZGİLİ SIVI SABUNLUK / LINE LIQUID SOAP DISPENSER	0,5 LT.	0,09	12	1,103	1,355	330 x 310 x 185	0,019	BOX	8697422308276
CZ016	ÇİZGİLİ KATI SABUNLUK / LINE SOAP HOLDER	-	0,034	36	1,224	1,369	305 x 200 x 195	0,012	BOX	8697422308283
CZ017	ÇİZGİLİ DIŞ FIRÇALIK / LINE TOOTHBRUSH HOLDER	-	0,06	18	1,12	1,33	335 x 235 x 225	0,018	BOX	8697422308290

PETEK DOKULU BANYO SERİSİ

HONEYCOMB EMBOSS BATHROOM COLLECTION

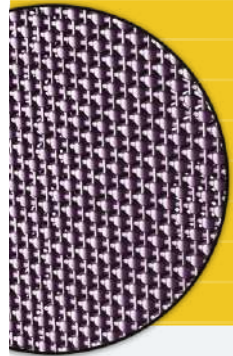

PACK TYPE



N008

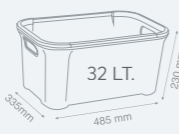

D079



N009



N010

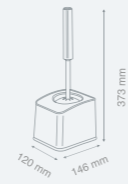

N011

N013



DESIGN CODE : X 38 | COLOR : GRI | GREY



DESIGN CODE : X 88 | COLOR : VIOLET | VIOLET



DESIGN CODE : X112 | COLOR : ROSE | ROSE



DESIGN CODE : X 24 | COLOR : BEYAZ | WHITE



DESIGN CODE : X 21 | COLOR : KREM | CREAM

5 prç. PETEK BANYO SETİ | HONEYCOMB BATH SET 5 pcs

ÜRÜN KODU PRODUCT CODE	ÜRÜN ADI AÇIKLAMA PRODUCT NAME	KAPASİTE CAPACITY LT.	TEK ÜRÜN AĞIRLIĞI PRODUCT WEIGHT	KOLİ İÇİ ADET PCS IN BOX	KOLİ NET NET WEIGHT	KOLİ BRÜT GROSS W.	KOLİ EBATI BOX DIMENSIONS (MM)	KOLİ m³ BOX m³	AMBALAJ ŞEKLİ PACKING TYPE	BARKOD EAN 13 CODE
N013	PETEK BANYO SETİ 5 prç. / HONEYCOMB BATH SET 5 pcs	-	3,1	1 set	3,1	3,86	470 x 370 x 580	0,1	COLOR BOX	8697422303387

HONEYCOMB EMBOSS
BATHROOM COLLECTION

PETEK DOKULU BANYO ÜRÜNLERİ

63 LT



N008

DESIGN CODE : X 88
COLOR : VIOLET | VIOLET



DESIGN CODE : X 21
COLOR : KREM | CREAM



DESIGN CODE : X 38
COLOR : GRI | GREY



DESIGN CODE : X 112
COLOR : ROSE | ROSE



DESIGN CODE : X 24
COLOR : BEYAZ | WHITE

32 LT



N015

DESIGN CODE : X 88
COLOR : VIOLET | VIOLET



DESIGN CODE : X 21
COLOR : KREM | CREAM

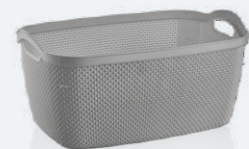

DESIGN CODE : X 38
COLOR : GRI | GREY



DESIGN CODE : X 112
COLOR : ROSE | ROSE



DESIGN CODE : X 24
COLOR : BEYAZ | WHITE



PACK TYPE

PETEK DOKULU ÜRÜNLER | HONEYCOMB EMOSS PRODUCTS

ÜRÜN KODU PRODUCT CODE	ÜRÜN ADI AÇIKLAMA PRODUCT NAME	KAPASİTE CAPACITY LT.	TEK ÜRÜN AĞIRLIĞI PRODUCT WEIGHT	KOLİ İÇİ ADET PCS IN BOX	KOLİ NET NET WEIGHT	KOLİ BRÜT GROSS W.	KOLİ EBATLARI BOX DIMENSIONS (MM)	KOLİ m ³ BOX m ³	AMBALAJ ŞEKLİ PACKING TYPE	BARKOD EAN 13 CODE
N008	PETEK KIRLI ÇAMAŞIR SEPETİ ve KAPAK / HONEYCOMB LAUNDRY BASKET & COVER	63 LT.	1,387	6	8,32	9,52	470 x 370 x 1015	0,176	BULK	8697422303325
N015	PETEK ÇAMAŞIR SEPETİ / HONEYCOMB CLOTHES BASKET	32 LT.	0,637	20	12,74	12,74	545 x 325 x 1230	0,218	BULK	8697422307040

HONEYCOMB BATHROOM PRODUCTS

6.2 LT



N010

DESIGN CODE : X 88
COLOR : VIOLET | VIOLET



DESIGN CODE : X 21
COLOR : KREM | CREAM



DESIGN CODE : X 38
COLOR : GRI | GREY



DESIGN CODE : X 112
COLOR : ROSE | ROSE



DESIGN CODE : X 24
COLOR : BEYAZ | WHITE

6.2 LT



N009

DESIGN CODE : X 88
COLOR : VIOLET | VIOLET



DESIGN CODE : X 21
COLOR : KREM | CREAM

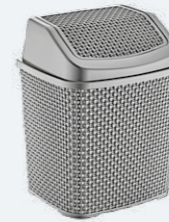

DESIGN CODE : X 38
COLOR : GRI | GREY



DESIGN CODE : X 112
COLOR : ROSE | ROSE



DESIGN CODE : X 24
COLOR : BEYAZ | WHITE

6.2 LT



N011

DESIGN CODE : X 88
COLOR : VIOLET | VIOLET



DESIGN CODE : X 21
COLOR : KREM | CREAM



DESIGN CODE : X 38
COLOR : GRI | GREY



DESIGN CODE : X 112
COLOR : ROSE | ROSE



DESIGN CODE : X 24
COLOR : BEYAZ | WHITE

PETEK DOKULU ÜRÜNLER | HONEYCOMB EMOSS PRODUCTS

ÜRÜN KODU PRODUCT CODE	ÜRÜN ADI AÇIKLAMA PRODUCT NAME	KAPASİTE CAPACITY LT.	TEK ÜRÜN AĞIRLIĞI PRODUCT WEIGHT	KOLİ İÇİ ADET PCS IN BOX	KOLİ NET NET WEIGHT	KOLİ BRÜT GROSS W.	KOLİ EBATLARI BOX DIMENSIONS (MM)	KOLİ m ³ BOX m ³	AMBALAJ ŞEKLİ PACKING TYPE	BARKOD EAN 13 CODE
N009	PETEK KLIK ÇÖP KOVASI / HONEYCOMB CLICK BIN	6,2 LT.	0,377	24	9,05	9,59	465 x 390 x 595	0,108	BOX	8697422303332
N010	PETEK DETERJANLIK / HONEYCOMB DETERGENT BOX	6,2 LT.	0,349	24	8,37	8,9	475 x 415 x 535	0,105	BOX	8697422303349
N011	PETEK KÜŞELİ WC FIRÇASI / HONEYCOMB RECT. WC BRUSH	-	0,188	20	4,51	5,12	610 x 390 x 410	0,1	BOX	8697422303356

DESENLI BANYO SETLERİ DECO BATHROOM SETS

D031



DESIGN CODE : X 129
SİYAH MERMER / BLACK MARBLE



DESIGN CODE : X 128
BEYAZ MERMER / WHITE MARBLE



DESIGN CODE : X 75
PARKE / PARQUET



DESIGN CODE : X 04
TAŞ / STONE

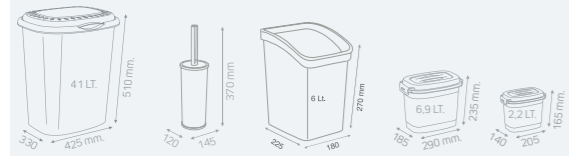

D0012-D0013 D018 D0081 D015 D016

5 prç. DESENLI BANYO SET | DECO BATHROOM 5 PCS

ÜRÜN KODU PRODUCT CODE	ÜRÜN ADI AÇIKLAMA PRODUCT NAME	KAPASİTE CAPACITY LT.	TEK ÜRÜN AĞIRLIĞI PRODUCT WEIGHT	KOLİ İÇİ ADET PCS IN BOX	KOLİ NET NET WEIGHT	KOLİ BRÜT GROSS W.	KOLİ EBATİ BOX DIMENSIONS (MM)	KOLİ m ³ BOX m ³	AMBALAJ ŞEKLİ PACKING TYPE	BARKOD EAN 13 CODE
D031	DESENLI 5 Prç. BANYO SETİ DEMONTE / 5 pcs DECO BATHROOM SET - DEMONTE	-	2,202	4 SET	8,808	10,04	-	0,131	BULK	8697422301277
D031	DESENLI 5 Prç. BANYO SETİ / 5 pcs DECO BATHROOM SET	-	2,202	4 SET	8,808	10,04	665 x 445 x 605	0,179	BOX	8697422301277
D080	1 NO DESENLI SMART KLIK ÇÖP KUVASI / 0 NO DECO SMART CLICK BIN	6 LT.	0,345	24	8,28	8,87	450 x 375 x 655	0,11	BOX	8697422307279

DESENLI ve METALİZE KIRLI ÇAMAŞIR SEPETLERİ DECO and METALLIC LAUNDRY BASKETS

D0012



DESIGN CODE : X 137
PEOPLE / PEOPLE

DESIGN CODE : X 138
MORNING / MORNING

DESIGN CODE : X 75
PARKE / PARQUET

D0013



DESIGN CODE : X 13
SADE METALİZE / PLAIN METALLIC



DESIGN CODE : X 128
BEYAZ MERMER
WHITE MARBLE



DESIGN CODE : X 04
TAŞ / STONE

D015

6,9
LT

DESIGN CODE : X 129
SİYAH MERMER
BLACK MARBLE



DESIGN CODE : X 118
VINTAGE LAVANTA
VINTAGE LAVANDER

D016



DESIGN CODE : X 04
TAŞ / STONE

DESIGN CODE : X 75
PARKE / PARQUET

DESIGN CODE : X 129
SİYAH MERMER
BLACK MARBLE

DESIGN CODE : X 128
BEYAZ MERMER
WHITE MARBLE

2,2
LT

KIRLI ÇAMAŞIR SEPETLERİ ve DETERJANLIKLAR | LAUNDRY BASKETS and DETERGENT BOXES

ÜRÜN KODU PRODUCT CODE	ÜRÜN ADI AÇIKLAMA PRODUCT NAME	KAPASİTE CAPACITY LT.	TEK ÜRÜN AĞIRLIĞI PRODUCT WEIGHT	KOLİ İÇİ ADET PCS IN BOX	KOLİ NET NET WEIGHT	KOLİ BRÜT GROSS W.	KOLİ EBATİ BOX DIMENSIONS (MM)	KOLİ m ³ BOX m ³	AMBALAJ ŞEKLİ PACKING TYPE	BARKOD EAN 13 CODE
D0012	DESENLI OVAL KIRLI ÇAMAŞIR SEPETİ ve KAPAK / DECO OVAL LAUNDRY BASKET & COVER	41 LT.	1,184	10	11,84	12,96	435 x 340 x 1070	0,158	BOX	8697422301123
D0012	DESENLI OVAL KIRLI ÇAMAŞIR SEPETİ ve KAPAK - DEMONTE / DECO OVAL LAUNDRY BASKET & COVER - DEMONTE	41 LT.	1,184	25	29,6	29,6	-	0,330	BULK	8697422301123
D0013	METALİZE OVAL KIRLI ÇAMAŞIR SEPETİ ve KAPAK / DECO OVAL LAUNDRY BASKET & COVER	41 LT.	1,184	10	11,84	12,96	435 x 340 x 1070	0,158	BOX	8697422306678
D0013	METALİZE OVAL KIRLI ÇAMAŞIR SEPETİ ve KAPAK - DEMONTE / DECO OVAL LAUNDRY BASKET & COVER - DEMONTE	41 LT.	1,184	25	29,6	29,6	-	0,330	BULK	8697422306678
D015	DESENLI DETERJANLIK / DECO DETERGENT BOX	6,9 LT.	0,322	24	7,728	8,35	625 x 370 x 435	0,101	BULK	8697422300942
D016	DESENLI KALGONLUK / DECO CALGON BOX	2,2 LT.	0,161	48	7,728	8,3	450 x 425 x 455	0,087	BOX	8697422300966

ÇOK AMAÇLI BANYO RAFLARI



B016

NEW



DESIGN CODE : X 129
SİYAH MERMER / BLACK MARBLE



DESIGN CODE : X 128
BEYAZ MERMER / WHITE MARBLE

B015



DESIGN CODE : X 38
GRI / GRAY



DESIGN CODE : X 24
BEYAZ / WHITE



DESIGN CODE : X 21
KREM / CREAM

895 mm

430 mm

375 mm

MULTIUSE BATH SHELVES

B012

NEW



DESIGN CODE : X 129
SİYAH MERMER / BLACK MARBLE



DESIGN CODE : X 128
BEYAZ MERMER / WHITE MARBLE

B013



DESIGN CODE : X 24
BEYAZ / WHITE



DESIGN CODE : X 38
GRI / GRAY



DESIGN CODE : X 21
KREM / CREAM

ÇOK AMAÇLI BANYO RAFLARI | MULTIUSE BATH SHELVES

ÜRÜN KODU PRODUCT CODE	ÜRÜN ADI AÇIKLAMA PRODUCT NAME	KAPASİTE CAPACITY LT.	TEK ÜRÜN AĞIRLIĞI PRODUCT WEIGHT	KOLİ İÇİ ADET PCS IN BOX	KOLİ NET NET WEIGHT	KOLİ BRÜT GROSS W.	KOLİ EBATLARI BOX DIMENSIONS (MM)	KOLİ m ³ BOX m ³	AMBALAJ ŞEKLİ PACKING TYPE	BARKOD EAN 13 CODE
B013	ÇOK AMAÇLI BANYO RAFI / MULTIUSE BATH SHELF	-	0,34	12	4,08	4,57	395 x 285 x 645	0,073	BOX	8697422307637
B012	DESENLİ ÇOK AMAÇLI BANYO RAFI / DECO MULTIUSE BATH SHELF	-	0,34	12	4,08	4,57	395 x 285 x 645	0,073	BOX	8697422307620
B015	2'Lİ ÇOK AMAÇLI BANYO RAFI / 2 TIER MULTIUSE BATH SHELF	-	0,265	24	6,36	7,18	550 x 400 x 485	0,106	BOX	8697422308320
B016	2'Lİ DESENLİ ÇOK AMAÇLI BANYO RAFI / 2 TIER DECO MULTIUSE BATH SHELF	-	0,265	24	6,36	7,18	550 x 400 x 485	0,106	BOX	8697422308337

BANYO KÖŞELİKLERİ



B011



DESIGN CODE : X 111
KARBON METALİZE
CARBON METALLIC



DESIGN CODE : X 13 - X 86
SİYAH SADE METALİZE
BLACK PLAIN METALLIC



DESIGN CODE : X 13 - X 24
BEYAZ SADE METALİZE
WHITE PLAIN METALLIC



BATH CORNER SHELVES

B009



DESIGN CODE : X 69
MAVİ / BLUE



DESIGN CODE : X 21
KREM / CREAM



DESIGN CODE : X 24
BEYAZ / WHITE

B010



DESIGN CODE : X 128
BEYAZ MERMER / WHITE MARBLE



DESIGN CODE : X 129
SİYAH MERMER / BLACK MARBLE

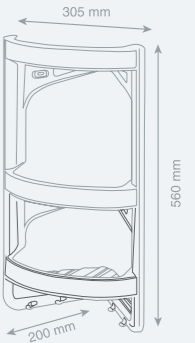

KURULUM VİDEOSU
SETUP VIDEO



Raflara her türlü banyo duş malzemelerinizi koyabilirsiniz. Banyo köşeliği ile beraber verilen dübel ve vida ile banyonuzun köşesini, matkap yardımıyla sağlam şekilde asabilirsiniz. En alt kısımdaki kancalara, asılabilecek banyo malzemelerinizi güvenli şekilde asabilirsiniz.

Every kind of shower stuff (shampoo, soap, blade etc), could be put on shelves Thanks to plastic dowel and screw (attached to product), you can hang the Corner Shelf easily and safely with the help of drill. Your shower accessories like sponges, washing clothes etc. could be hanged to the hooks at the bottom side.

BANYO KÖŞELİKLERİ | BATH CORNER SHELVES

ÜRÜN KODU PRODUCT CODE	ÜRÜN ADI AÇIKLAMA PRODUCT NAME	KAPASİTE CAPACITY LT.	TEK ÜRÜN AĞIRLIĞI PRODUCT WEIGHT	KOLİ İÇİ ADET PCS IN BOX	KOLİ NET NET WEIGHT	KOLİ BRÜT GROSS W.	KOLİ EBATLARI BOX DIMENSIONS (MM)	KOLİ m ³ BOX m ³	AMBALAJ ŞEKLİ PACKING TYPE	BARKOD EAN 13 CODE
B009	BANYO KÖŞELİĞİ / BATH CORNER SHELF	-	0,38	12	4,56	5,14	490 x 310 x 550	0,084	BOX	8697422307484
B010	DESENİLİ BANYO KÖŞELİĞİ / DECO BATH CORNER SHELF	-	0,38	12	4,56	5,14	490 x 310 x 550	0,084	BOX	8697422307491
B011	METALİZE BANYO KÖŞELİĞİ / METALLIC BATH CORNER SHELF	-	0,38	12	4,56	5,14	490 x 310 x 550	0,084	BOX	8697422307507

02



GENEL KULLANIM
GENERAL USAGE

PRATİK ve ŞIKLIK
PRACTICAL and CLASSINESS

SLİM METALİZE PEDALLI ÇÖP KOVALARI



■ S132 İç Kovalı / With Inner Bucket
S132-1 İç Kovasız / Without Inner Bucket **NEW**



DESIGN CODE : X 158
DOMİNO METALİZE | DOMİNO METALLIC



DESIGN CODE : X 13
SADE METALİZE | PLAIN METALLIC

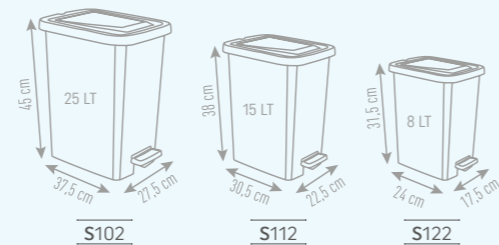

SLİM METALLIC STEP BINS



25 LT



■ S102 İç Kovalı / With Inner Bucket
S102-1 İç Kovasız / Without Inner Bucket



NEW



15 LT



■ S112 İç Kovalı / With Inner Bucket
S112-1 İç Kovasız / Without Inner Bucket



8 LT



■ S122 İç Kovalı / With Inner Bucket
S122-1 İç Kovasız / Without Inner Bucket



DESIGN CODE : X 158
DOMİNO METALİZE | DOMİNO METALLIC

DESIGN CODE : X 13
SADE METALİZE | PLAIN METALLIC



SLİM METALİZE PEDALLI ÇÖP KOVALARI | SLİM METALLIC STEP BINS

ÜRÜN KODU PRODUCT CODE	ÜRÜN ADI AÇIKLAMA PRODUCT NAME	KAPASİTE CAPACITY LT.	TEK ÜRÜN AĞIRLIĞI PRODUCT WEIGHT	KOLİ İÇİ ADET PCS IN BOX	KOLİ NET NET WEIGHT	KOLİ BRÜT GROSS W.	KOLİ EBATLARI BOX DIMENSIONS (MM)	KOLİ M ³ BOX m ³	AMBALAJ ŞEKLİ PACKING TYPE	BARKOD EAN 13 CODE
S132	3'LÜ SLİM METALİZE PEDALLI ÇÖP KOVASI SET / 3 PCS SLİM METALLIC STEP BIN SET	25+15+8	4,18	1 SET	4,18	4,52	385 x 285 x 465	0,051	BOX	8697422307958
S132-1	3'LÜ SLİM METALİZE PEDALLI ÇÖP KOVASI SET (İÇ KOVASIZ) / 3 PCS SLİM METALLIC STEP BIN SET (WITHOUT INNER BUCKET)	25+15+8	2,6	1 SET	2,6	2,94	385 x 285 x 465	0,051	BOX	8697422307989
S102	25 LT. SLİM METALİZE PEDALLI ÇÖP KOVASI / 25 LT. SLİM METALLIC STEP BIN	25 LT.	2,02	4	8,60	9,13	560 x 390 x 690	0,15	BOX	8697422307668
S102-1	25 LT. SLİM METALİZE PEDALLI ÇÖP KOVASI (İÇ KOVASIZ) / 25 LT. SLİM METALLIC STEP BIN (WITHOUT INNER BUCKET)	25 LT.	1,24	4	4,96	5,50	560 x 390 x 545	0,12	BOX	8697422307804
S112	15 LT. SLİM METALİZE PEDALLI ÇÖP KOVASI / 15 LT. SLİM METALLIC STEP BIN	15 LT.	1,26	6	7,6	8,51	700 x 325 x 610	0,13	BOX	8697422307835
S112-1	15 LT. SLİM METALİZE PEDALLI ÇÖP KOVASI (İÇ KOVASIZ) / 15 LT. SLİM METALLIC STEP BIN (WITHOUT INNER BUCKET)	15 LT.	0,795	6	4,77	5,4	700 x 325 x 485	0,11	BOX	8697422307866
S122	8 LT. SLİM METALİZE PEDALLI ÇÖP KOVASI / 8 LT. SLİM METALLIC STEP BIN	8 LT.	0,715	12	8,58	9,28	550 x 535 x 520	0,15	BOX	8697422307897
S122-1	8 LT. SLİM METALİZE PEDALLI ÇÖP KOVASI (İÇ KOVASIZ) / 8 LT. SLİM METALLIC STEP BIN (WITHOUT INNER BUCKET)	8 LT.	0,458	12	5,50	5,80	550 x 530 x 415	0,12	BOX	8697422307927

SLİM PEDALLI ÇÖP KOVALARI



■ S130 İç Kovalı / With Inner Bucket
S133-1 İç Kovasız / Without Inner Bucket

NEW



SLİM STEP BINS

NEW



■ S100 İç Kovalı / With Inner Bucket
S103-1 İç Kovasız / Without Inner Bucket

15 LT



■ S110 İç Kovalı / With Inner Bucket
S113-1 İç Kovasız / Without Inner Bucket

8 LT



■ S120 İç Kovalı / With Inner Bucket
S123-1 İç Kovasız / Without Inner Bucket

DESIGN CODE : X 72
YEŞİL & GRİ | GREEN & GREY

DESIGN CODE : X 38
GÜMÜŞ & GRİ | SILVER & GREY

DESIGN CODE : X 24
BEYAZ | WHITE

SLİM PEDALLI ÇÖP KOVALARI | SLİM STEP BINS

ÜRÜN KODU PRODUCT CODE	ÜRÜN ADI AÇIKLAMA PRODUCT NAME	KAPASİTE CAPACITY LT.	TEK ÜRÜN AĞIRLIĞI PRODUCT WEIGHT	KOLİ İÇİ ADET PCS IN BOX	KOLİ NET NET WEIGHT	KOLİ BRÜT GROSS W.	KOLİ EBATLARI BOX DIMENSIONS (MM)	KOLİ m ³ BOX m ³	AMBALAJ ŞEKLİ PACKING TYPE	BARKOD EAN 13 CODE
S130	3'LÜ SLİM PEDALLI ÇÖP KOVASI SET / 3 PCS SLİM STEP BIN SET	25+15+8	4,18	1 SET	4,18	4,52	385 x 285 x 465	0,051	BOX	8697422307934
S133-1	3'LÜ SLİM PEDALLI ÇÖP KOVASI SET (İÇ KOVASIZ) / 3 PCS SLİM STEP BIN SET (WITHOUT INNER BUCKET)	25+15+8	2,6	1 SET	2,6	2,94	385 x 285 x 465	0,051	BOX	8697422307965
S100	25 LT. SLİM PEDALLI ÇÖP KOVASI / 25 LT. SLİM STEP BIN	25 LT.	1,98	4	7,84	9,02	560 x 390 x 690	0,15	BOX	8697422307644
S103-1	25 LT. SLİM PEDALLI ÇÖP KOVASI (İÇ KOVASIZ) / 25 LT. SLİM STEP BIN (WITHOUT INNER BUCKET)	25 LT.	1,14	4	4,56	5,13	560 x 390 x 545	0,12	BOX	8697422307685
S110	15 LT. SLİM PEDALLI ÇÖP KOVASI / 15 LT. SLİM STEP BIN	15 LT.	1,26	6	7,6	8,51	700 x 325 x 610	0,13	BOX	8697422307811
S113-1	15 LT. SLİM PEDALLI ÇÖP KOVASI (İÇ KOVASIZ) / 15 LT. SLİM STEP BIN (WITHOUT INNER BUCKET)	15 LT.	0,795	6	4,77	5,4	700 x 325 x 485	0,11	BOX	8697422307842
S120	8 LT. SLİM PEDALLI ÇÖP KOVASI / 8 LT. SLİM STEP BIN	8 LT.	0,715	12	8,58	9,28	550 x 535 x 520	0,15	BOX	8697422307873
S123-1	8 LT. SLİM PEDALLI ÇÖP KOVASI (İÇ KOVASIZ) / 8 LT. SLİM STEP BIN (WITHOUT INNER BUCKET)	8 LT.	0,458	12	5,50	5,80	550 x 530 x 415	0,12	BOX	8697422307903

DESENLI SLİM PEDALLI ÇÖP KOVALARI



S131 İç Kovalı / With Inner Bucket
S131-1 İç Kovasız / Without Inner Bucket

NEW



DESIGN CODE : X 138
MORNING



DESIGN CODE : X 137
PEOPLE



DESIGN CODE : X 128
BEYAZ MERMER | WHITE MARBLE



DESIGN CODE : X 129
SİYAH MERMER | BLACK MARBLE



SLİM DECO STEP BINS

NEW

25 LT



S101 İç Kovalı / With Inner Bucket
S101-1 İç Kovasız / Without Inner Bucket

15 LT



S111 İç Kovalı / With Inner Bucket
S111-1 İç Kovasız / Without Inner Bucket

8 LT



S121 İç Kovalı / With Inner Bucket
S121-1 İç Kovasız / Without Inner Bucket

DESIGN CODE : X 129
SİYAH MERMER
BLACK MARBLE

DESIGN CODE : X 128
BEYAZ MERMER
WHITE MARBLE

DESIGN CODE : X 137
PEOPLE

DESIGN CODE : X 138
MORNING

DESENLI SLİM PEDALLI ÇÖP KOVALARI | SLİM DECO STEP BINS

ÜRÜN KODU PRODUCT CODE	ÜRÜN ADI AÇIKLAMA PRODUCT NAME	KAPASİTE CAPACITY LT.	TEK ÜRÜN AĞIRLIĞI PRODUCT WEIGHT kg	KOLİ İÇİ ADET PCS IN BOX	KOLİ NET NET WEIGHT	KOLİ BRÜT GROSS W.	KOLİ EBATLARI BOX DIMENSIONS (MM)	KOLİ M ³ BOX m ³	AMBALAJ ŞEKLİ PACKING TYPE	BARKOD EAN 13 CODE
S131	3'LÜ SLİM DESENLI PEDALLI ÇÖP KOVASI SET / 3 PCS SLİM DECO STEP BIN SET	25+15+8	4,18	1 SET	4,18	4,52	385 x 285 x 465	0,051	BOX	8697422307941
S131-1	3'LÜ SLİM DESENLI PEDALLI ÇÖP KOVASI SET (İÇ KOVASIZ) / 3 PCS SLİM DECO STEP BIN SET (WITHOUT INNER BUCKET)	25+15+8	2,6	1 SET	2,6	2,94	385 x 285 x 465	0,051	BOX	8697422307972
S101	25 LT. SLİM DESENLI PEDALLI ÇÖP KOVASI / 25 LT. SLİM DECO STEP BIN	25 LT.	2,02	4	8,60	9,14	560 x 390 x 690	0,15	BOX	8697422307651
S101-1	25 LT. SLİM DESENLI PEDALLI ÇÖP KOVASI (İÇ KOVASIZ) / 25 LT. SLİM DECO STEP BIN (WITHOUT INNER BUCKET)	25 LT.	1,26	4	5,04	5,59	560 x 390 x 545	0,12	BOX	8697422307798
S111	15 LT. SLİM DESENLI PEDALLI ÇÖP KOVASI / 15 LT. SLİM DECO STEP BIN	15 LT.	1,26	6	7,6	8,51	700 x 325 x 610	0,13	BOX	8697422307828
S111-1	15 LT. SLİM DESENLI PEDALLI ÇÖP KOVASI (İÇ KOVASIZ) / 15 LT. SLİM DECO STEP BIN (WITHOUT INNER BUCKET)	15 LT.	0,795	6	4,77	5,4	700 x 325 x 485	0,11	BOX	8697422307859
S121	8 LT. SLİM DESENLI PEDALLI ÇÖP KOVASI / 8 LT. SLİM DECO STEP BIN	8 LT.	0,715	12	8,58	9,28	550 x 535 x 520	0,15	BOX	8697422307880
S121-1	8 LT. SLİM DESENLI PEDALLI ÇÖP KOVASI (İÇ KOVASIZ) / 8 LT. SLİM DECO STEP BIN (WITHOUT INNER BUCKET)	8 LT.	0,458	12	5,50	5,80	550 x 530 x 415	0,12	BOX	8697422307880

ÇİZGİLİ PEDALLI ÇÖP KOVALARI



DESIGN CODE : X 38 | GRİ | GRAY

CZ005.

NEW



DESIGN CODE : X 86 | SİYAH | BLACK



DESIGN CODE : X 24 | BEYAZ | WHITE



DESIGN CODE : X 161 | KUM BEJİ | SAND BEIGE

LINE STEP BINS

20 LT



CZ004.

NEW

11 LT



CZ003.

6 LT



CZ002.

DESIGN CODE : X 86
SİYAH | BLACKDESIGN CODE : X 161
KUM BEJİ | SAND BEIGEDESIGN CODE : X 24
BEYAZ | WHITEDESIGN CODE : X 38
GRİ | GRAY

ÇİZGİLİ PEDALLI ÇÖP KOVALARI | LINE STEP BINS

ÜRÜN KODU PRODUCT CODE	ÜRÜN ADI AÇIKLAMA PRODUCT NAME	KAPASİTE CAPACITY LT.	TEK ÜRÜN AĞIRLIĞI PRODUCT WEIGHT KG	KOLİ İÇİ ADET PCS IN BOX	KOLİ NET NET WEIGHT KG	KOLİ BRÜT GROSS W. KG	KOLİ EBATLARI BOX DIMENSIONS (MM)	KOLİ m ³ BOX m ³	AMBALAJ ŞEKLİ PACKING TYPE	BARKOD EAN 13 CODE
CZ005	3'LÜ ÇİZGİLİ PEDALLI ÇÖP KOVASI SET / LINE 3 PCS. STEP BIN SET	20 LT. + 11 LT. + 6 LT.	3,31	1 SET	6,304	3,27	335 x 335 x 400	0,05	COLOR BOX	869742230 8122
CZ004	4 NO ÇİZGİLİ PEDALLI ÇÖP KOVASI / LINE STEP BIN NO : 4	20 LT.	1,7	6	7,392	10,2	960 x 645 x 410	0,25	BOX	869742230 8092
CZ003	3 NO ÇİZGİLİ PEDALLI ÇÖP KOVASI / LINE STEP BIN NO : 3	11 LT.	0,99	12	6,888	11,88	785 x 520 x 690	0,29	BOX	869742230 8108
CZ002	2 NO ÇİZGİLİ PEDALLI ÇÖP KOVASI / LINE STEP BIN NO : 2	6 LT.	0,62	12	6,304	7,44	620 x 420 x 535	0,15	BOX	869742230 8115

DALGALI PEDALLI ÇÖP KOVALARI

WAVY STEP BINS



DL004.

NEW



DESIGN CODE : X 86 | SİYAH | BLACK



DESIGN CODE : X 24 | BEYAZ | WHITE



DESIGN CODE : X 38 | GRİ | GRAY

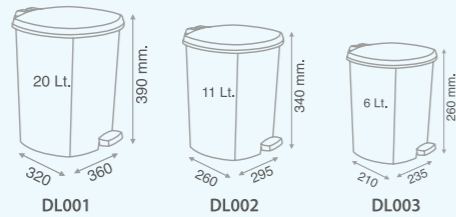

DESIGN CODE : X 161 | KUM BEJİ | SAND BEIGE

20 LT



DL001.

11 LT



DL002.

6 LT



DL003.

DESIGN CODE : X 86
SİYAH | BLACKDESIGN CODE : X 161
KUM BEJİ | SAND BEIGEDESIGN CODE : X 24
BEYAZ | WHITEDESIGN CODE : X 38
GRİ | GRAY

DALGALI PEDALLI ÇÖP KOVALARI | WAVY STEP BINS

ÜRÜN KODU PRODUCT CODE	ÜRÜN ADI AÇIKLAMA PRODUCT NAME	KAPASİTE CAPACITY LT.	TEK ÜRÜN AĞIRLIĞI PRODUCT WEIGHT	KOLİ İÇİ ADET PCS IN BOX	KOLİ NET NET WEIGHT	KOLİ BRÜT GROSS W.	KOLİ EBATLARI BOX DIMENSIONS (MM)	KOLİ m ³ BOX m ³	AMBALAJ ŞEKLİ PACKING TYPE	BARKOD EAN 13 CODE
DL004	3'LÜ DALGALI PEDALLI ÇÖP KOVASI SET / WAVY 3 PCS. STEP BIN SET	20 LT. + 11 LT. + 6 LT.	3,31	1 SET	6,304	3,27	335 x 335 x 400	0,05	COLOR BOX	8697422308122
DL001	4 NO DALGALI PEDALLI ÇÖP KOVASI / WAVY STEP BIN NO : 4	20 LT.	1,7	6	7,392	10,2	960 x 645 x 410	0,25	BOX	8697422308092
DL002	3 NO DALGALI PEDALLI ÇÖP KOVASI / WAVY STEP BIN NO : 3	11 LT.	0,99	12	6,888	11,88	785 x 520 x 690	0,29	BOX	8697422308108
DL003	2 NO DALGALI PEDALLI ÇÖP KOVASI / WAVY STEP BIN NO : 2	6 LT.	0,62	12	6,304	7,44	620 x 420 x 535	0,15	BOX	8697422308115

DESENLI 3'lü PEDALLI ÇÖP KOVASI SETLERİ

3 pcs DECO STEP BIN SETS

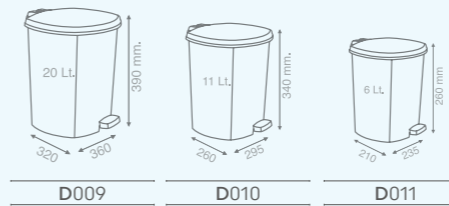

PACK TYPE



3 BOY DESENLI PEDALLI ÇÖP KOVASI SET | 3 pcs DECO STEP BIN SET

ÜRÜN KODU PRODUCT CODE	ÜRÜN ADI AÇIKLAMA PRODUCT NAME	KAPASİTE CAPACITY LT.	TEK ÜRÜN AĞIRLIĞI PRODUCT WEIGHT	KOLİ İÇİ ADET PCS IN BOX	KOLİ NET NET WEIGHT	KOLİ BRÜT GROSS W.	KOLİ EBATLARI BOX DIMENSIONS (MM)	KOLİ m ³ BOX m ³	AMBALAJ ŞEKLİ PACKING TYPE	BARKOD EAN 13 CODE
D044	3 BOY DESENLI PEDALLI ÇÖP KOVASI SET / 3 pcs DECO STEP BIN SET	6+11+20 LT.	3,250	1 set	3,250	3,686	340 x 330 x 402	0,045	COLOR BOX	8697422301239

DESENLİ ve METALİZE PEDALLI ÇÖP KOVALARI

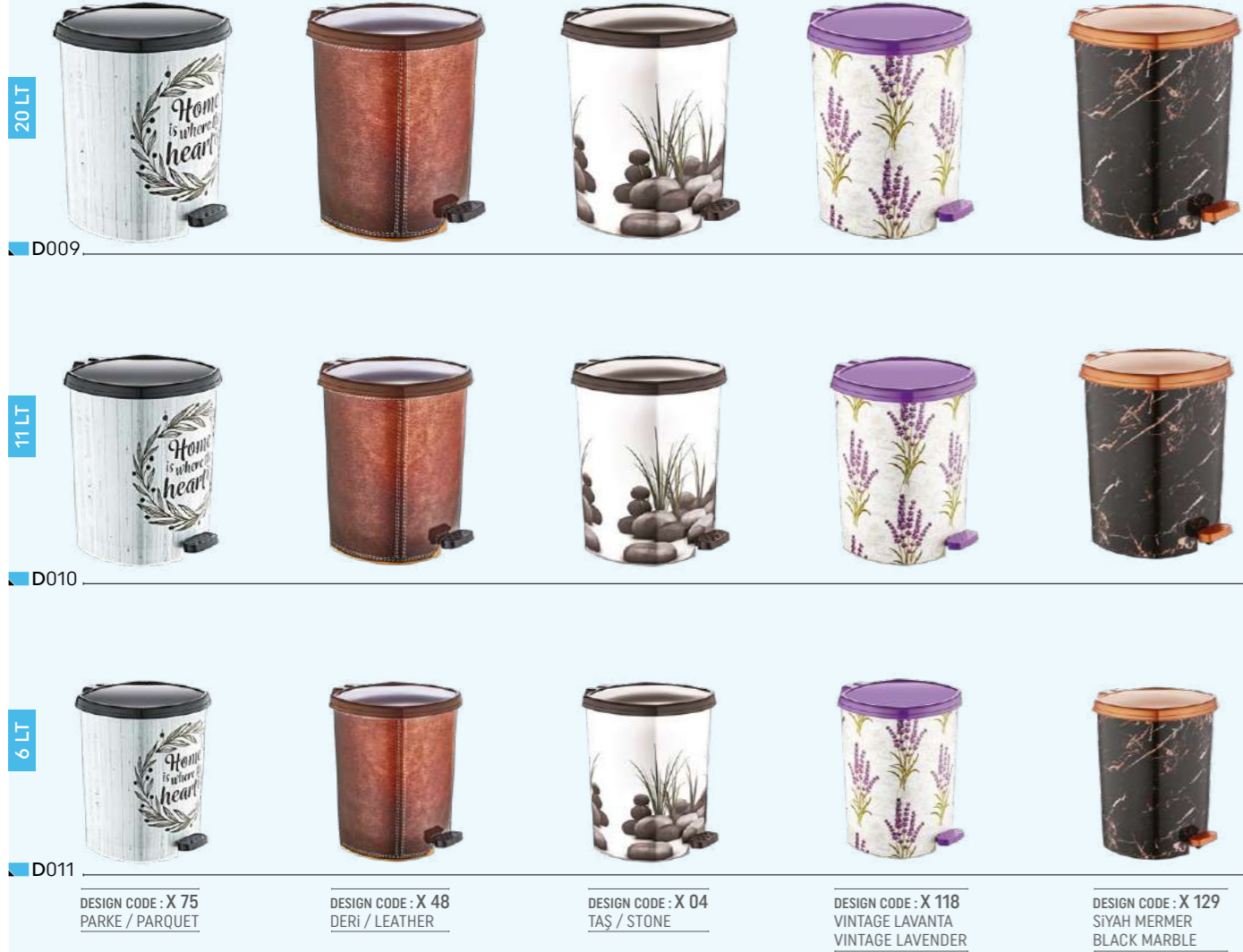

DESENLİ ve METALİZE PEDALLI ÇÖP KOVALARI | DECO and METALLIC STEP BINS

ÜRÜN KODU PRODUCT CODE	ÜRÜN ADI AÇIKLAMA PRODUCT NAME	KAPASİTE CAPACITY LT.	TEK ÜRÜN AĞIRLIĞI PRODUCT WEIGHT	KOLİ İÇİ ADET PCS IN BOX	KOLİ NET NET WEIGHT	KOLİ BRÜT GROSS W.	KOLİ EBATI BOX DIMENSIONS (MM)	KOLİ m³ BOX m³	AMBALAJ ŞEKLİ PACKING TYPE	BARKOD EAN 13 CODE
D009	4 NO DESENLİ PEDALLI ÇÖP KOVASI / DECO STEP BIN NO: 4	20 LT.	1,7	6	10,46	12,10	960 x 645 x 410	0,254	BOX	8697422301864
D010	3 NO DESENLİ PEDALLI ÇÖP KOVASI / DECO STEP BIN NO: 3	11 LT.	1,02	12	12,24	13,80	785 x 520 x 690	0,282	BOX	8697422301871
D011	2 NO DESENLİ PEDALLI ÇÖP KOVASI / DECO STEP BIN NO: 2	6 LT.	0,59	12	8,12	7,67	620 x 420 x 535	0,147	BOX	8697422301888
D002	4 NO METALİZE PEDALLI ÇÖP KOVASI / METALLIC STEP BIN NO: 4	20 LT.	1,7	6	10,46	12,10	960 x 645 x 410	0,254	BOX	8697422300997
D003	3 NO METALİZE PEDALLI ÇÖP KOVASI / METALLIC STEP BIN NO: 3	11 LT.	1,02	12	12,24	13,80	785 x 520 x 690	0,282	BOX	8697422300980
D004	2 NO METALİZE PEDALLI ÇÖP KOVASI / METALLIC STEP BIN NO: 2	6 LT.	0,59	12	8,12	7,67	620 x 420 x 535	0,147	BOX	8697422300973
D045	3 BOY METALİZE PEDALLI ÇÖP KOVASI SET / 3 pcs METALLIC STEP BIN SET	6+11+20 LT.	3,250	1 set	3,250	3,686	340 x 330 x 402	0,045	COLOR BOX	8697422301239



DECO and METALLIC STEP BINS



D002 D003 D004



DESIGN CODE : X 13 | SADE METALİZE | PLAIN METALLIC



DESIGN CODE : X 158 | DOMINO



D009



D010



D011

DESIGN CODE : X 128
BEYAZ MERMER
WHITE MARBLE

DESIGN CODE : X 138
MORNING / MORNING

DESIGN CODE : X 137
PEOPLE/ PEOPLE



NEW

DESIGN CODE : X 13
SADE METALİZE
PLAIN METALLIC



DECO METALLIC STEP BINS

SADE-DESENLI-METALIZE GRANDE PLAIN / DECO / METALLIC

ÇÖP KOVALARI GRANDE STEP BINS

50 LT



D097



DESIGN CODE : X 13
SADE METAL / PLAIN METALLIC

KURULUM VIDEOSU
SETUP VIDEO

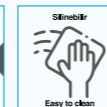
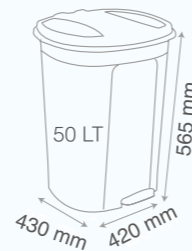

D095

DESIGN CODE : X 38 | GRİ | GRAY



D096

DESIGN CODE : X 129
SİYAH MERMER / BLACK MARBLE



D096

DESIGN CODE : X 128
BEYAZ MERMER / WHITE MARBLE



D095

DESIGN CODE : X 24 | WHITE | BEYAZ



D096

DESIGN CODE : X 138 | MORNING



D096

DESIGN CODE : X 137 | PEOPLE

SADE - DESENLI ve METALIZE GRANDE ÇÖP KOVALARI | PLAIN DECO METALLIC GRANDE STEP BINS

ÜRÜN KODU PRODUCT CODE	ÜRÜN ADI AÇIKLAMA PRODUCT NAME	KAPASİTE CAPACITY LT.	TEK ÜRÜN AĞIRLIĞI PRODUCT WEIGHT	KOLI İÇİ ADET PCS IN BOX	KOLI NET NET WEIGHT	KOLI BRÜT GROSS W.	KOLI EBATI BOX DIMENSIONS (MM)	KOLI m ³ BOX m ³	AMBALAJ ŞEKLİ PACKING TYPE	BARKOD EAN 13 CODE
D095	GRANDE PEDALLI ÇÖP KOVASI - DEMONTE / GRANDE PEDAL BIN - DEMONTE	50 LT.	3	4	12	12,8	450 x 450 x 960	0,19	BOX	8697422307514
D096	DESENLI GRANDE PEDALLI ÇÖP KOVASI - DEMONTE / DECO GRANDE PEDAL BIN - DEMONTE	50 LT.	3,3	4	13,2	14	450 x 450 x 960	0,19	BOX	8697422307521
D097	METALIZE GRANDE PEDALLI ÇÖP KOVASI - DEMONTE / METALLIC GRANDE PEDAL BIN - DEMONTE	50 LT.	3,3	4	13,2	14	450 x 450 x 960	0,19	BOX	8697422307545
D095	GRANDE PEDALLI ÇÖP KOVASI / GRANDE PEDAL BIN	50 LT.	3	1	13,2	3,7	435 x 435 x 580	0,109	BOX	8697422307514
D096	DESENLI GRANDE PEDALLI ÇÖP KOVASI / DECO GRANDE PEDAL BIN	50 LT.	3,3	1	3,3	4	435 x 435 x 580	0,109	BOX	8697422307521
D097	METALIZE GRANDE PEDALLI ÇÖP KOVASI / METALLIC GRANDE PEDAL BIN	50 LT.	3,3	1	3,3	4	435 x 435 x 580	0,109	BOX	8697422307545

METALİZE SMART KLİK ÇÖP KOVALARI



D090



DESIGN CODE : X 13 | SADE METALİZE / PLAIN METALLIC

D090



DESIGN CODE : X 158 | DOMINO METALİZE / DOMINO METALLIC

METALLIC SMART CLICK BINS

**PACK
TYPE**
0 NO
3,3 LTDESIGN CODE : X 13
SADE METALİZE / PLAIN METALLIC1 NO
6 LT2 NO
11,6 LT3 NO
23 LT

D083

DESIGN CODE : X 158
DOMINO METALİZE / DOMINO METALLIC

D084



D085



D093

NEW

METALLIC SMART CLICK BINS

METALİZE KLİK SMART ÇÖP KOVALARI | METALLIC CLICK SMART BINS

ÜRÜN KODU PRODUCT CODE	ÜRÜN ADI AÇIKLAMA PRODUCT NAME	KAPASİTE CAPACITY LT.	TEK ÜRÜN AĞIRLIĞI PRODUCT WEIGHT	KOLİ İÇİ ADET PCS IN BOX	KOLİ NET NET WEIGHT	KOLİ BRÜT GROSS W.	KOLİ EBATLARI BOX DIMENSIONS (MM)	KOLİ m ³ BOX m ³	AMBALAJ ŞEKLİ PACKING TYPE	BARKOD EAN 13 CODE
D083	0 NO METALİZE SMART KLİK ÇÖP KOVASI / 0 NO METALLIC SMART CLICK BIN	3,3 LT.	0,187	24	4,49	3,59	375 x 305 x 540	0,062	BOX	8697422307293
D084	1 NO METALİZE SMART KLİK ÇÖP KOVASI / 1 NO METALLIC SMART CLICK BIN	6 LT.	0,345	24	8,28	3,49	450 x 375 x 655	0,11	BOX	8697422307309
D085	2 NO METALİZE SMART KLİK ÇÖP KOVASI / 2 NO METALLIC SMART CLICK BIN	11,6 LT.	0,6	12	6,516	7,2	565 x 455 x 540	0,138	BOX	8697422307316
D090	METALİZE SMART KLİK ÇÖP KOVASI 3'Ü SET / 3 PCS METALLIC SMART CLICK BIN SET	3,3 + 6 + 11,6 LT.	1,13	1	7,584	1,13	285 x 220 x 360	0,023	COLOR BOX	8697422307415
D093	3 NO METALİZE SMART KLİK ÇÖP KOVASI / 3 NO METALLIC SMART CLICK BIN	23 LT.	1,05	12	6,236	12,6	710 x 550 x 570	0,22	BOX	8697422307422

DESENLİ SMART KLİK ÇÖP KOVALARI

DECO SMART CLICK BINS

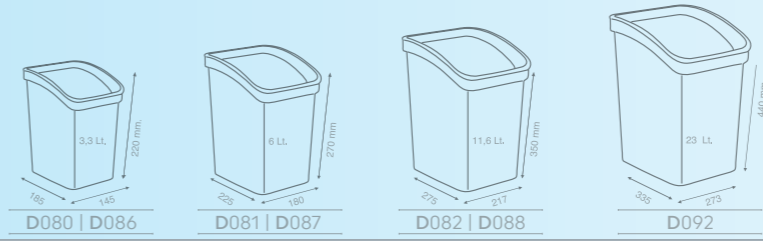

DESENLİ SMART KLİK ÇÖP KOVALARI | DECO SMART CLICK BINS

ÜRÜN KODU PRODUCT CODE	ÜRÜN ADI AÇIKLAMA PRODUCT NAME	KAPASİTE CAPACITY LT.	TEK ÜRÜN AĞIRLIĞI PRODUCT WEIGHT	KOLİ İÇİ ADET PCS IN BOX	KOLİ NET NET WEIGHT	KOLİ BRÜT GROSS W.	KOLİ EBATI BOX DIMENSIONS (MM)	KOLİ m³ BOX m³	AMBALAJ ŞEKLİ PACKING TYPE	BARKOD EAN 13 CODE
D089	DESENLİ SMART KLİK ÇÖP KOVASI 3'lü SET / 3 PCS DECO SMART CLICK BIN SET	3,3 + 6 + 11,6 LT.	1,3	1	1,13	1,41	285 x 220 x 360	0,023	COLOR BOX	8697422307408
D091	SMART KLİK ÇÖP KOVASI 3'lü SET / 3 PCS SMART CLICK BIN SET	3,3 + 6 + 11,6 LT.	1,3	1	1,13	1,41	285 x 220 x 360	0,023	COLOR BOX	8697422307422

DESENLI SMART KLİK ÇÖP KOVALARI

DECO SMART CLICK BINS

D080



D081



D082

DESIGN CODE : X 138
MORNING
MORNINGDESIGN CODE : X 137
PEOPLE
PEOPLEDESIGN CODE : X 129
SIYAH MERMER
BLACK MARBLEDESIGN CODE : X 128
BEYAZ MERMER
WHITE MARBLEDESIGN CODE : X 75
PARKE
PARQUETDESIGN CODE : X 118
VINTAGE LAVANTA
VINTAGE LAVANDER

DESENLI SMART KLİK ÇÖP KOVALARI | DECO SMART CLICK BINS

ÜRÜN KODU PRODUCT CODE	ÜRÜN ADI AÇIKLAMA PRODUCT NAME	KAPASİTE CAPACITY LT.	TEK ÜRÜN AĞIRLIĞI PRODUCT WEIGHT	KOLİ İÇİ ADET PCS IN BOX	KOLİ NET NET WEIGHT	KOLİ BRÜT GROSS W.	KOLİ EBATLARI BOX DIMENSIONS (MM)	KOLİ m ³ BOX m ³	AMBALAJ ŞEKLİ PACKING TYPE	BARKOD EAN 13 CODE
D080	0 NO DESENLI SMART KLİK ÇÖP KOVASI / 0 NO DECO SMART CLICK BIN	3,3 LT.	0,187	24	4,49	4,88	375 x 305 x 540	0,062	BOX	8697422307262
D081	1 NO DESENLI SMART KLİK ÇÖP KOVASI / 1 NO DECO SMART CLICK BIN	6 LT.	0,345	24	8,28	8,87	450 x 375 x 655	0,11	BOX	8697422307279
D082	2 NO DESENLI SMART KLİK ÇÖP KOVASI / 2 NO DECO SMART CLICK BIN	11,6 LT.	0,6	12	7,2	8	565 x 455 x 540	0,138	BOX	8697422307286
D092	3 NO DESENLI SMART KLİK ÇÖP KOVASI / 3 NO DECO SMART CLICK BIN	23 LT.	1,05	12	12,6	14	710 x 550 x 570	0,22	BOX	8697422307439
D086	0 NO SMART KLİK ÇÖP KOVASI / 0 NO SMART CLICK BIN	3,3 LT.	0,187	24	4,49	4,88	375 x 305 x 540	0,062	BOX	8697422307323
D087	1 NO SMART KLİK ÇÖP KOVASI / 1 NO SMART CLICK BIN	6 LT.	0,345	24	8,28	8,87	450 x 375 x 655	0,11	BOX	8697422307330

SMART KLİK ÇÖP KOVALARI

SMART CLICK BINS

D086



D087



D088

DESIGN CODE : X 86
SIYAH
BLACKDESIGN CODE : X 24
BEYAZ
WHITEDESIGN CODE : X 21
KREM
CREAM

D092

DESIGN CODE : X 138
MORNING
MORNINGDESIGN CODE : X 137
PEOPLE
PEOPLEDESIGN CODE : X 129
SIYAH MERMER
BLACK MARBLEDESIGN CODE : X 128
BEYAZ MERMER
WHITE MARBLE

D094

DESIGN CODE : X 86
SIYAH
BLACKDESIGN CODE : X 24
BEYAZ
WHITEDESIGN CODE : X 21
KREM
CREAM

SMART KLİK ÇÖP KOVALARI | SMART CLICK BINS

ÜRÜN KODU PRODUCT CODE	ÜRÜN ADI AÇIKLAMA PRODUCT NAME	KAPASİTE CAPACITY LT.	TEK ÜRÜN AĞIRLIĞI PRODUCT WEIGHT	KOLİ İÇİ ADET PCS IN BOX	KOLİ NET NET WEIGHT	KOLİ BRÜT GROSS W.	KOLİ EBATLARI BOX DIMENSIONS (MM)	KOLİ m ³ BOX m ³	AMBALAJ ŞEKLİ PACKING TYPE	BARKOD EAN 13 CODE
D088	2 NO SMART KLİK ÇÖP KOVASI / 2 NO SMART CLICK BIN	11,6 LT.	0,6	12	7,2	8	565 x 455 x 540	0,138	BOX	8697422307347
D094	3 NO SMART KLİK ÇÖP KOVASI / 3 NO SMART CLICK BIN	23 LT.	1,05	12	12,6	14	710 x 550 x 570	0,22	BOX	8697422307347

DALGALI ve PETEK DOKULU KLİK ÇÖP KOVALARI

WAVY and HONEYCOMB EMBOS CLICK BINS



DL006

NEW



DESIGN CODE : X 86 | SİYAH | BLACK



DESIGN CODE : X 38 | GRİ | GRAY



DESIGN CODE : X 161 | KUM BEJİ | SAND BEIGE



DESIGN CODE : X 24 | BEYAZ | WHITE

N009



DESIGN CODE : X 88 | VİOLET | VIOLET

185 mm

DESIGN CODE : X 24 | BEYAZ | WHITE

275 mm

235 mm

DESIGN CODE : X 21 | KREM | CREAM

DESIGN CODE : X 112 | ROSE | ROSE

DESIGN CODE : X 38 | GRİ | GREY

DALGALI ve PETEK KLİK ÇÖP KOVALARI | WAVY and HONEYCOMB CLICK BINS

ÜRÜN KODU PRODUCT CODE	ÜRÜN ADI AÇIKLAMA PRODUCT NAME	KAPASİTE CAPACITY LT.	TEK ÜRÜN AĞIRLIĞI PRODUCT WEIGHT	KOLİ İÇİ ADET PCS IN BOX	KOLİ NET NET WEIGHT	KOLİ BRÜT GROSS W.	KOLİ EBATLARI BOX DIMENSIONS (MM)	KOLİ m ³ BOX m ³	AMBALAJ ŞEKLİ PACKING TYPE	BARKOD EAN 13 CODE
DL006	DALGALI KLİK ÇÖP KOVASI / WAVY CLICK BIN	6,2 LT.	0,377	24	9,05	9,05	465 x 390 x 595	0,108	BOX	8697422308054
N009	PETEK KLİK ÇÖP KOVASI / HONEYCOMB CLICK BIN	6,2 LT.	0,377	24	9,05	9,05	465 x 390 x 595	0,108	BOX	8697422303332

ELBİSE ASKILARI

CLOTHES HANGERS

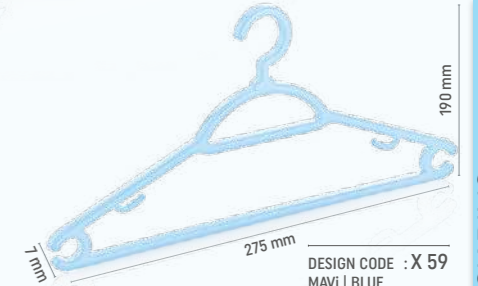
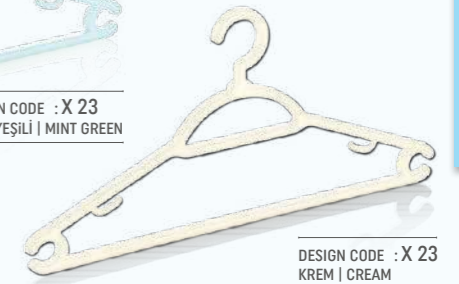
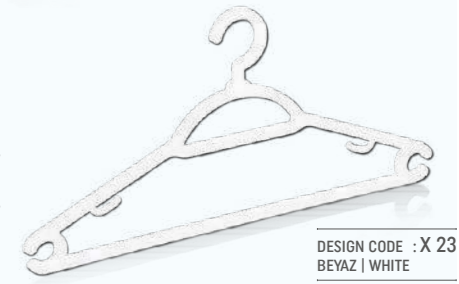

A005

DESIGN CODE : X 65
AÇIK PEMBE | LIGHT PINKDESIGN CODE : X 59
MAVİ | BLUEDESIGN CODE : X 23
MİNT YEŞİLİ | MINT GREENDESIGN CODE : X 23
KREM | CREAMDESIGN CODE : X 23
KAHVE | BROWNDESIGN CODE : X 23
BEYAZ | WHITE

ASKILAR | CLOTHES HANGERS

ÜRÜN KODU PRODUCT CODE	ÜRÜN ADI AÇIKLAMA PRODUCT NAME	KAPASİTE CAPACITY LT.	TEK ÜRÜN AĞIRLIĞI PRODUCT WEIGHT	KOLİ İÇİ ADET PCS IN BOX	KOLİ NET NET WEIGHT	KOLİ BRÜT GROSS W.	KOLİ EBATLARI BOX DIMENSIONS (MM)	KOLİ m ³ BOX m ³	AMBALAJ ŞEKLİ PACKING TYPE	BARKOD EAN 13 CODE
A005	ELBİSE ASKISI 6'lı / CLOTHES HANGER 6 PCS	-	0,04	192	8	8,46	490 x 405 x 405	0,08	SLEEVE CARD + BOX	8697422302489

DALGALI ve PETEK KOMODİNLER



DL010

NEW



DESIGN CODE : X 161
KUM BEJİ | SAND BEIGE



DESIGN CODE : X 24 | BEYAZ | WHITE



DESIGN CODE : X 38 | GRİ | GRAY

EKO DALGALI KOMODİN | ECO WAVY COMMODO

ÜRÜN KODU PRODUCT CODE	ÜRÜN ADI AÇIKLAMA PRODUCT NAME	KAPASİTE CAPACITY LT.	TEK ÜRÜN AĞIRLIĞI PRODUCT WEIGHT	KOLİ İÇİ ADET PCS IN BOX	KOLİ NET NET WEIGHT	KOLİ BRÜT GROSS W.	KOLİ EBATİ BOX DIMENSIONS (MM)	KOLİ m ³ BOX m ³	AMBALAJ ŞEKLİ PACKING TYPE	BARKOD EAN 13 CODE
DL010	EKO DALGALI KOMODİN / ECO WAVY COMMODO	-	4,38	1	4,38	4,63	400 x 410 x 395	0,064	SHRINK	8697422308313

WAVY and HONEYCOMB EMBOSS COMMODOES

K013



DESIGN CODE : X 24 | BEYAZ | WHITE



DESIGN CODE : X 38 | GRİ | GRAY



DESIGN CODE : X 161 | KUM BEJİ | SAND BEIGE

K037

ECONOMİK SERİ ECONOMIC SERIE

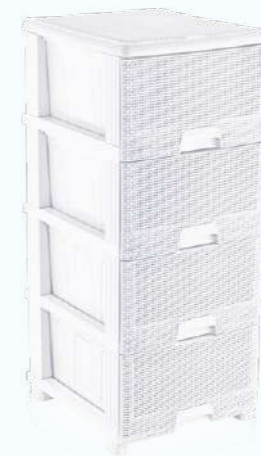

PETEK DOKULU ve EKONOMİK KOMODİN | HONEYCOMB EMBOSS and ECONOMIC COMMODO

ÜRÜN KODU PRODUCT CODE	ÜRÜN ADI AÇIKLAMA PRODUCT NAME	KAPASİTE CAPACITY LT.	TEK ÜRÜN AĞIRLIĞI PRODUCT WEIGHT	KOLİ İÇİ ADET PCS IN BOX	KOLİ NET NET WEIGHT	KOLİ BRÜT GROSS W.	KOLİ EBATİ BOX DIMENSIONS (MM)	KOLİ m ³ BOX m ³	AMBALAJ ŞEKLİ PACKING TYPE	BARKOD EAN 13 CODE
K013	PETEK KOMODİN / HONEYCOMB COMMODO	-	4,84	1	4,84	5	395 x 402 x 410	0,069	SHRINK	8697422303486
K037	EKO PETEK KOMODİN / EKO HONEYCOMB COMMODO	-	4,44	1	4,44	4,6	395 x 402 x 410	0,069	SHRINK	8697422303516

DESENLİ ve AĖŞAP DOKULU KOMODİNLER

DECO and WOODEN EMBOSS COMMODES



K012



DESIGN CODE : X 75
PARKE | PARQUET



DESIGN CODE : X 04
TAŞ | STONE



DESIGN CODE : X 118
VINTAGE LAVANTA
VINTAGE LAVANDER



DESIGN CODE : X 128
BEYAZ MERMER
WHITE MARBLE



DESIGN CODE : X 129
SİYAH MERMER
BLACK MARBLE

K019



DESIGN CODE : X 23
KAHVE | CREAM BROWN

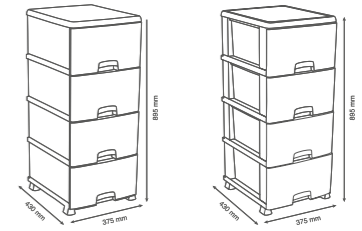

K013 | K037 | K012 | K019

DESENLİ ve AĖŞAP DOKULU KOMODİN | DECO and WOODEN EMBOSS COMMODE

ÜRÜN KODU PRODUCT CODE	ÜRÜN ADI AÇIKLAMA PRODUCT NAME	KAPASİTE CAPACITY LT.	TEK ÜRÜN AĞIRLIĞI PRODUCT WEIGHT	KOLİ İÇİ ADET PCS IN BOX	KOLİ NET NET WEIGHT	KOLİ BRÜT GROSS W.	KOLİ EBATLARI BOX DIMENSIONS (MM)	KOLİ m ³ BOX m ³	AMBALAJ ŞEKLİ PACKING TYPE	BARKOD EAN 13 CODE
K012	DESENLİ KOMODİN / DECO COMMODE	-	4,87	1	4,87	5,03	39,5 x 42 x 41	0,069	SHRINK	8697422303479
K019	AĖŞAP DOKULU KOMODİN / WOODEN EMBOSS COMMODE	-	4,87	1	4,87	5,03	39,5 x 42 x 41	0,069	SHRINK	8697422307514

KATLI BASAMAKLAR

DOUBLE STEP STOOLS

B001



DESIGN CODE : X 21 KREM | CREAM



DESIGN CODE : X 69 MAVİ | BLUE



DESIGN CODE : X 66 YEŞİL | GREEN



DESIGN CODE : X 24 BEYAZ | WHITE



KAYMAZ AYAKLAR
NON - SLIP RUBBER FEET

B004

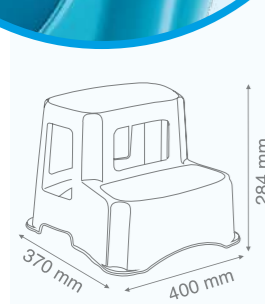

B001 | B004



DESIGN CODE : X 83 PARIS | PARIS



DESIGN CODE : X 84 BAYKUŞ | OWL



DESIGN CODE : X 85 ORKİDE | ORCHID

KATLI BASAMAKLAR | DOUBLE STEP STOOLS

ÜRÜN KODU PRODUCT CODE	ÜRÜN ADI AÇIKLAMA PRODUCT NAME	KAPASİTE CAPACITY LT.	TEK ÜRÜN AĞIRLIĞI PRODUCT WEIGHT	KOLİ İÇİ ADET PCS IN BOX	KOLİ NET NET WEIGHT	KOLİ BRÜT GROSS W.	KOLİ EBATİ BOX DIMENSIONS (MM)	KOLİ m ³ BOX m ³	AMBALAJ ŞEKLİ PACKING TYPE	BARKOD EAN 13 CODE
B001	KATLI BASAMAK / DOUBLE STEP STOOL	-	0,960	12	11,52	11,60	400 x 370 x 740	0,11	BULK	8697422302519
B004	DESENLİ KATLI BASAMAK / DECO DOUBLE STEP STOOL	-	1040	12	12,48	12,48	400 x 370 x 740	0,11	BULK	8697422302557

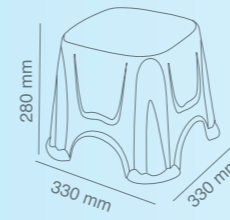

MAXİ ORTA BOY TABURELER

MAXİ MIDDLE SIZE STOOLS

T010



DESIGN CODE : X 69 MAVİ | BLUE



DESIGN CODE : X 24 BEYAZ | WHITE



DESIGN CODE : X 38 GRİ | GRAY



DESIGN CODE : X 21 KREM | CREAM

T011



DESIGN CODE : XT 006



DESIGN CODE : XT 003



DESIGN CODE : XT 005



DESIGN CODE : XT 004



DESIGN CODE : XT 002

TABURELER | STOOLS

ÜRÜN KODU PRODUCT CODE	ÜRÜN ADI AÇIKLAMA PRODUCT NAME	KAPASİTE CAPACITY LT.	TEK ÜRÜN AĞIRLIĞI PRODUCT WEIGHT	KOLİ İÇİ ADET PCS IN BOX	KOLİ NET NET WEIGHT	KOLİ BRÜT GROSS W.	KOLİ EBATİ BOX DIMENSIONS (MM)	KOLİ m ³ BOX m ³	AMBALAJ ŞEKLİ PACKING TYPE	BARKOD EAN 13 CODE
T010	MAXİ ORTA BOY TABURE / MAXİ MIDDLE SIZE STOOL	-	0,587	25	14,68	14,68	330 x 330 x 1240	0,135	POLY BAG	8697422307460
T011	DESENLİ MAXİ ORTA BOY TABURE / DECO MAXİ MIDDLE SIZE STOOL	-	0,587	25	14,68	14,68	330 x 330 x 1240	0,135	POLY BAG	8697422307477

DOUBLE STEP STOOLS
MAXİ MIDDLE SIZE STOOLS

HASIR DOKULU TABURELER RATTAN STOOLS

KATLANIR SEHPA FOLDABLE SIDE TABLE

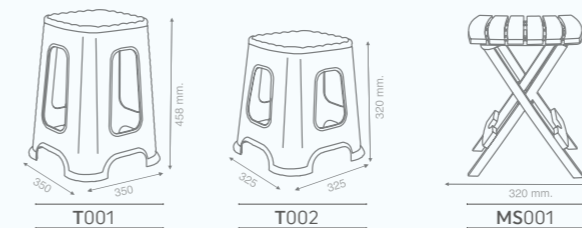
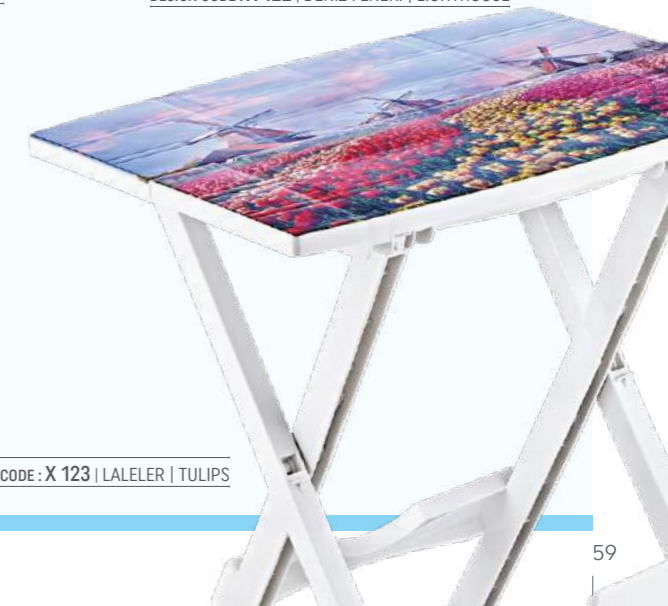

TABURELER ve KATLANIR SEHPA | RATTAN STOOLS and FOLDABLE SIDE TABLE

ÜRÜN KODU PRODUCT CODE	ÜRÜN ADI AÇIKLAMA PRODUCT NAME	KAPASİTE CAPACITY LT.	TEK ÜRÜN AĞIRLIĞI PRODUCT WEIGHT	KOLİ İÇİ ADET PCS IN BOX	KOLİ NET NET WEIGHT	KOLİ BRÜT GROSS W.	KOLİ EBATLARI BOX DIMENSIONS (MM)	KOLİ m ³ BOX m ³	AMBALAJ ŞEKLİ PACKING TYPE	BARKOD EAN 13 CODE
T002	ORTA BOY HASIR TABURE / MIDDLE SIZE RATTAN STOOL	-	0,7	20	14,4	14,4	325 x 325 x 142	0,150	BULK	8697422301727
T001	BÜYÜK HASIR TABURE / BIG RATTAN STOOL	-	1	12	12	12	355 x 355 x 106	0,134	BULK	8697422301734
MS001	KATLANIR SEHPA / FOLDABLE SIDE TABLE	-	1,574	10	15,74	18,5	765 x 455 x 590	0,2	SLEEVE CARD+BOX	8697422303370
MS003	DESENLİ KATLANIR SEHPA / FOLDABLE SIDE TABLE	-	1,552	10	15,52	16,78	680 x 455 x 590	0,18	BOX	8697422303400

DESENLi AYAKKABILIK DECO SHOES RACK

ÇOK AMAÇLI DESENLi DAR TEKERLEKLi RAF DECO MULTIUSE SLIM RACK WITH WHEELS



A003



DESIGN CODE : X 157 | LAMINANT | LAMINATE



DESIGN CODE : X 129 | SIYAH MERMER | BLACK MARBLE



DESIGN CODE : X 120 | AHŞAP | WOODEN



DESIGN CODE : X 48 | DERİ | LEATHER

KURULUM VİDEOSU
SETUP VIDEO



DESENLi AYAKKABILIK VE ÇOK AMAÇLI DAR RAF | DECO SHOES RACK AND MULTIUSE SLIM RACK

ÜRÜN KODU PRODUCT CODE	ÜRÜN ADI AÇIKLAMA PRODUCT NAME	KAPASİTE CAPACITY LT.	TEK ÜRÜN AĞIRLIĞI PRODUCT WEIGHT	KOLİ İÇİ ADET PCS IN BOX	KOLİ NET NET WEIGHT	KOLİ BRÜT GROSS W.	KOLİ EBATI BOX DIMENSIONS (MM)	KOLİ m ³ BOX m ³	AMBALAJ ŞEKLİ PACKING TYPE	BARKOD EAN 13 CODE
A003	DESENLi AYAKKABILIK / DECO SHOES RACK	-	1,63	6	9,82	10,81	585 x 485 x 468	0,13	BOX	8697422307590
D098	DESENLi ÇOK AMAÇLI DAR TEKERLEKLi RAF / DECO MULTIUSE SLIM RACK WITH WHEELS	-	1,32	6	7,95	8,59	490 x 405 x 530	0,105	BOX	8697422307569



D098



DESIGN CODE : X 141 | HAPPY TIME



DESIGN CODE : X 129 | SIYAH MERMER | BLACK MARBLE



DESIGN CODE : X 128 | BEYAZ MERMER | BEYAZ MARBLE



DESIGN CODE : X 142 | VEGAN | VEGAN



KİLERDE | at CELLARROOM



MUTFAKTA | at KITCHEN



BANYODA | at BATHROOM

KURULUM VİDEOSU
SETUP VIDEO

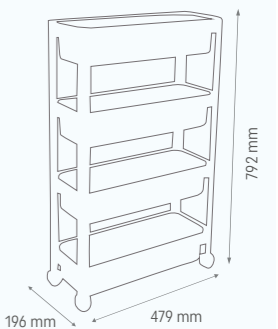

DESENLİ ÇOK AMAÇLI DİKDÖRTGEN TEKERLEKLİ RAF

DECO MULTIUSE RECTANGULAR RACK WITH WHEELS



KURULUM VİDEOSU
SETUP VIDEO



S097



DESIGN CODE : X 141 | HAPPY TIME | HAPPY TIME



DESIGN CODE : X 129 | SİYAH MERMER | BLACK MARBLE



DESIGN CODE : X 142 | VEGAN | VEGAN



DESIGN CODE : X 157 | LAMINANT | LAMINATE



DESIGN CODE : X 128 | BEYAZ MERMER | BEYAZ MARBLE

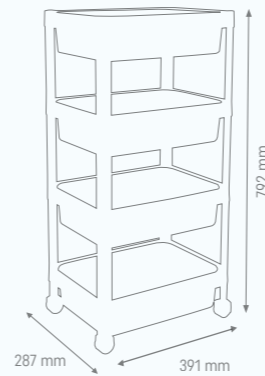

DESENLİ ÇOK AMAÇLI DİKDÖRTGEN TEKERLEKLİ RAF | DECO MULTIUSE RECTANGULAR RACK WITH WHEELS

ÜRÜN KODU PRODUCT CODE	ÜRÜN ADI AÇIKLAMA PRODUCT NAME	KAPASİTE CAPACITY LT.	TEK ÜRÜN AĞIRLIĞI PRODUCT WEIGHT	KOLİ İÇİ ADET PCS IN BOX	KOLİ NET NET WEIGHT	KOLİ BRÜT GROSS W.	KOLİ EBATLARI BOX DIMENSIONS (MM)	KOLİ m ³ BOX m ³	AMBALAJ ŞEKLİ PACKING TYPE	BARKOD EAN 13 CODE
S097	DESENLİ ÇOK AMAÇLI DİKDÖRTGEN TEKERLEKLİ RAF / DECO MULTIUSE SLIM RACK WITH WHEELS	-	1,282	6	7,69	8,69	290 x 395 x 520	0,12	BOX	869742237613

DECO MULTIUSE RECTANGULAR
RACK WITH WHEELS



03

TEMİZLİK GRUBU
CLEANING ACCESSORIES

HiJYEN ve RAHATLIK
HYGIENE and CONTROL

DALGALI ve PETEK DOKULU WC FIRÇALARI



WAVY and HONEYCOMB WC BRUSHES

DL008



DESIGN CODE : X 86 | SIYAH | BLACK



DESIGN CODE : X 38 | GRI | GRAY



DESIGN CODE : X 24 | BEYAZ | WHITE



DESIGN CODE : X 161 | KUM BEJİ | SAND BEIGE

NEW

N011



DESIGN CODE : X 21 | KREM | CREAM



DESIGN CODE : X 112 | ROSE



DESIGN CODE : X 88 | VIOLET



DESIGN CODE : X 24 | BEYAZ | WHITE



DESIGN CODE : X 38 | GRI | GREY

DOKULU WC FIRÇALARI | EMBOSS WC BRUSHES

ÜRÜN KODU PRODUCT CODE	ÜRÜN ADI AÇIKLAMA PRODUCT NAME	KAPASİTE CAPACITY LT.	TEK ÜRÜN AĞIRLIĞI PRODUCT WEIGHT	KOLİ İÇİ ADET PCS IN BOX	KOLİ NET NET WEIGHT	KOLİ BRÜT GROSS W.	KOLİ EBATLARI BOX DIMENSIONS (MM)	KOLİ m ³ BOX m ³	AMBALAJ ŞEKLİ PACKING TYPE	BARKOD EAN 13 CODE
DL008	DALGALI KÖŞELİ WC FIRÇASI / WAVY RECTANGLE WC BRUSH	-	0,185	24	4,44	5,05	610 x 390 x 415	0,1	BOX	8697422308078
N011	PETEK KÖŞELİ WC FIRÇASI / HONEYCOMB RECTANGLE WC BRUSH	-	0,188	24	4,51	5,12	610 x 390 x 415	0,1	BOX	8697422303356

WAVY and HONEYCOMB
WC BRUSHES

DESENLİ ve METALİZE OVAL WC FIRÇALARI

DECO and METALLIC OVAL WC BRUSHES

D026



DESİGN CODE : X 75 | PARKE | PARQUET

DESİGN CODE : X 129 | SİYAH MERMER | BLACK MARBLE

DESİGN CODE : X 128 | BEYAZ MERMER | WHITE MARBLE

DESİGN CODE : X 04 | TAŞ | STONE

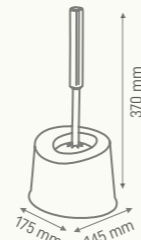

D027

DESİGN CODE : X 13
SADE METALİZE | PLAIN METALLICDESİGN CODE : X 158
DOMİNO

D026 | D027



NEW

KÖŞELİ WC FIRÇALARI

RECTANGLE WC BRUSHES

D022



DESİGN CODE : X 137 | PEOPLE

DESİGN CODE : X 138 | MORNING

DESİGN CODE : X 118
VINTAGE LAVANTA
VINTAGE LAVANDERDESİGN CODE : X 04
TAŞ | STONEDESİGN CODE : X 75
PARKE | PARQUETDESİGN CODE : X 129
SİYAH MERMER
BLACK MARBLEDESİGN CODE : X 128
BEYAZ MERMER
WHITE MARBLE

D023

DESİGN CODE : X 13
SADE METALİZE | PLAIN METALLICDESİGN CODE : X 158
DOMİNO

NEW

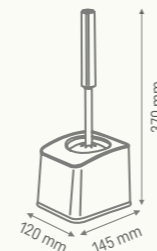

D022 | D023



DESENLİ ve METALİZE WC FIRÇALARI | DECO and METALLIC WC BRUSHES

ÜRÜN KODU PRODUCT CODE	ÜRÜN ADI AÇIKLAMA PRODUCT NAME	KAPASİTE CAPACITY LT.	TEK ÜRÜN AĞIRLIĞI PRODUCT WEIGHT	KOLİ İÇİ ADET PCS IN BOX	KOLİ NET NET WEIGHT	KOLİ BRÜT GROSS W.	KOLİ EBATI BOX DIMENSIONS (MM)	KOLİ m ³ BOX m ³	AMBALAJ ŞEKLİ PACKING TYPE	BARKOD EAN 13 CODE
D 026	DESENLİ OVAL WC FIRÇASI / DECO OVAL WC BRUSH	-	0,183	24	4,392	5,06	607 x 387 x 510	0,120	BOX	8697422301307
D 027	METALİZE OVAL WC FIRÇASI / METALLIC OVAL WC BRUSH	-	0,185	24	4,44	5,1	607 x 387 x 510	0,120	BOX	8697422301345
D 022	DESENLİ KÖŞELİ WC FIRÇASI / DECO RECTANGLE WC BRUSH	-	0,185	24	4,44	5,05	610 x 390 x 415	0,1	BOX	8697422301178
D 023	METALİZE KÖŞELİ WC FIRÇASI / METALLIC RECTANGLE WC BRUSH	-	0,192	24	4,608	5,22	610 x 390 x 415	0,1	BOX	8697422301192

DESENLi ve METALiZE YUVARLAK WC FIRÇALARI DECO and METALLIC ROUND WC BRUSHES

D018.

DESIGN CODE : X 04
TAŞ | STONE

DESIGN CODE : X 138 | MORNING



DESIGN CODE : X 137 | PEOPLE

DESIGN CODE : X 75
PARKE | PARQUETDESIGN CODE : X 118
VINTAGE LAVANTA
VINTAGE LAVANDERDESIGN CODE : X 128
BEYAZ MERMER
WHITE MARBLEDESIGN CODE : X 129
SİYAH MERMER
BLACK MARBLE

D020.

DESIGN CODE : X 13
SADE METALiZE
PLAIN METALLICDESIGN CODE : X 158
DOMINO
DOMINO

NEW

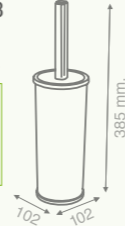

D018 | D020

YUVARLAK WC FIRÇALAR ve MAŞRAPALAR | ROUND WC BRUSHES and PITCHERS

ÜRÜN KODU PRODUCT CODE	ÜRÜN ADI AÇIKLAMA PRODUCT NAME	KAPASİTE CAPACITY LT.	TEK ÜRÜN AĞIRLIĞI PRODUCT WEIGHT	KOLİ İÇİ ADET PCS IN BOX	KOLİ NET NET WEIGHT	KOLİ BRÜT GROSS W.	KOLİ EBATI BOX DIMENSIONS (MM)	KOLİ m ³ BOX m ³	AMBALAJ ŞEKLİ PACKING TYPE	BARKOD EAN 13 CODE
D018	DESENLi YUVARLAK WC FIRÇASI / DECO ROUND WC BRUSH	-	0,203	24	4,872	5,53	630 x 425 x 390	0,104	BOX	8697422301062
D020	METALiZE YUVARLAK WC FIRÇASI / METALLIC ROUND WC BRUSH	-	0,203	24	4,872	5,53	630 x 425 x 390	0,104	BOX	8697422301079
M007	DESENLi MAŞRAPA / DECO PITCHER FOR TOILET	1,4 LT.	0,081	72	5,832	5,832	415 x 280 x 580	0,067	POLY BAG	8697422301130
D025	METALiZE MAŞRAPA / METALLIC PITCHER FOR TOILET	1,4 LT.	0,082	72	5,904	5,904	415 x 280 x 580	0,067	POLY BAG	8697422301352

MAŞRAPALAR PITCHERS

M007.



DESIGN CODE : X 111 | KARBON | KARBON



DESIGN CODE : X 04 | TAŞ | STONE



DESIGN CODE : X 75 | PARKE | PARQUET



DESIGN CODE : X 129 | SİYAH MERMER | BLACK MARBLE



DESIGN CODE : X 128 | BEYAZ MERMER | WHITE MARBLE

D025.



NEW



DESENLi TEMİZLİK ve SU KOVALARI

DECO CLEANING and WATER BUCKETS



D012

14 LT



DESIGN CODE : X 75 | PARKE | PARQUET



DESIGN CODE : X 129 | SİYAH MERMER | BLACK MARBLE



DESIGN CODE : X 137 | PEOPLE | PEOPLE



DESIGN CODE : X 128 | BEYAZ MERMER | WHITE MARBLE



DESIGN CODE : X 118 | VINTAGE LAVANTA | VINTAGE LAVANDER



DESIGN CODE : X 04 | TAŞ | STONE

K001

16 LT



DESIGN CODE : X 15 | OKYANUS | OCEAN



DESIGN CODE : X 118 | VINTAGE LAVANTA | VINTAGE LAVANDER



DESIGN CODE : X 40 | PERİ | FAİRY



DESIGN CODE : X 16 | PRENSES | PRINCESS



DESIGN CODE : X 14 | HAYVANLI | ANIMALS



DESIGN CODE : X 41 | ARABALAR | CARS



DESIGN CODE : X 80 | MARİN | MARINE

K027

21 LT



DESIGN CODE : X 101S | ŞEFFAF SİYAH | CLEAR BLACK

K024

16 LT



K027

21 LT



DESIGN CODE : X 89 | SAFİR | SAPPHIRE

K024

16 LT



K002 | K027



K001 | K024

WATER BUCKETS

TEMİZLİK ve SU KOVALARI | CLEANING and WATER BUCKETS

ÜRÜN KODU PRODUCT CODE	ÜRÜN ADI AÇIKLAMA PRODUCT NAME	KAPASİTE CAPACITY LT.	TEK ÜRÜN AĞIRLIĞI PRODUCT WEIGHT	KOLİ İÇİ ADET PCS IN BOX	KOLİ NET NET WEIGHT	KOLİ BRÜT GROSS W.	KOLİ EBATI BOX DIMENSIONS (MM)	KOLİ m ³ BOX m ³	AMBALAJ ŞEKLİ PACKING TYPE	BARKOD EAN 13 CODE
D012	DESENLi TEMİZLİK KOVASI ve SIKMA / DECO CLEANING BUCKET and WRINGER	14 LT.	0,609	24	14,16	15,74	580 x 400 x 545	0,126	BOX	8697422300874
K001	4 NO DESENLi SU KOVASI ve KAPAK / 4 NO DECO WATER BUCKET and COVER	16 LT.	0,623	50	31,15	31,15	?	0,287	BULK	8697422300911
K024	SAFİR SU KOVASI NO: 4 ve KAPAK / SAPPHIRE WATER BUCKET NO: 4 COVER	16 LT.	0,623	50	31,15	31,15	?	0,287	BULK	8697422303554
K027	SAFİR SU KOVASI NO: 5 ve KAPAK / SAPPHIRE WATER BUCKET NO: 5 COVER	21 LT.	0,725	50	36,25	36,25	?	0,372	BULK	8697422303417

04



MUTFAK ÜRÜNLERİ
KITCHEN PRODUCTS

DÜZEN ve SAĞLIK
TIDY and HEALTHY

KÖŞELİ KİLİTLİ SAKLAMA KAPLARI

RECTANGLE LOCKED CONTAINERS

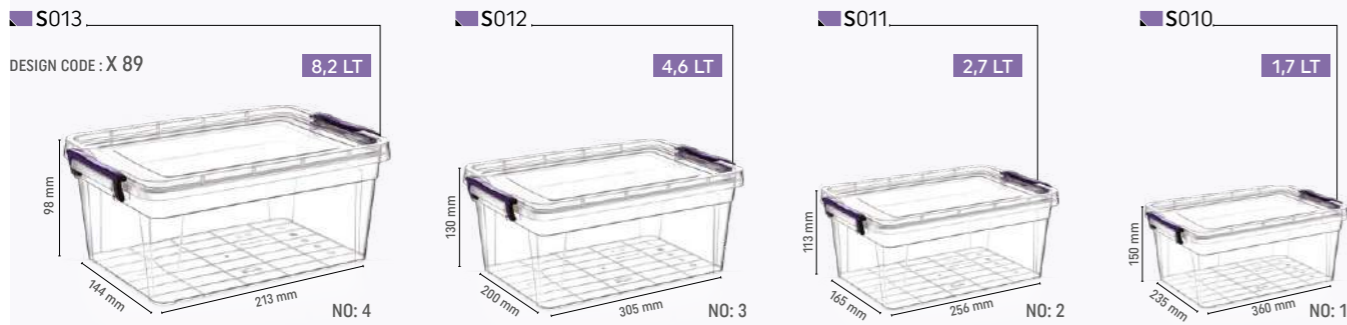

ÜRÜN KODU PRODUCT CODE	ÜRÜN ADI AÇIKLAMA PRODUCT NAME	KAPASİTE CAPACITY LT.	TEK ÜRÜN AĞIRLIĞI PRODUCT WEIGHT	KOLİ İÇİ ADET PCS IN BOX	KOLİ NET NET WEIGHT	KOLİ BRÜT GROSS W.	KOLİ EBATLARI BOX DIMENSIONS (MM)	KOLİ m³ BOX m³	AMBALAJ ŞEKLİ PACKING TYPE	BARKOD EAN 13 CODE
S010	1 NO KÖŞELİ KİLİTLİ SAKLAMA KABI / RECTANGLE LOCKED CONTAINER NO: 1	1,7 LT.	0,111	48	5,328	5,76	475 x 290 x 450	0,162	BOX	8697422301543
S011	2 NO KÖŞELİ KİLİTLİ SAKLAMA KABI / RECTANGLE LOCKED CONTAINER NO: 2	2,7 LT.	0,185	48	8,88	9,61	565 x 340 x 463	0,089	BOX	8697422301550
S012	3 NO KÖŞELİ KİLİTLİ SAKLAMA KABI / RECTANGLE LOCKED CONTAINER NO: 3	4,6 LT.	0,288	24	6,912	7,41	415 x 340 x 510	0,072	BOX	8697422301567
S013	4 NO KÖŞELİ KİLİTLİ SAKLAMA KABI / RECTANGLE LOCKED CONTAINER NO: 4	8,2	0,384	24	9,216	9,84	490 x 390 x 540	0,103	BOX	8697422301574
S014	5 NO KÖŞELİ KİLİTLİ SAKLAMA KABI / RECTANGLE LOCKED CONTAINER NO: 5	15	0,538	12	6,456	7,04	435 x 290 x 640	0,081	BOX	8697422301635
S015	6 NO KÖŞELİ KİLİTLİ SAKLAMA KABI / RECTANGLE LOCKED CONTAINER NO: 6	20	0,76	12	9,12	9,77	495 x 330 x 765	0,110	BOX	8697422301642
S019	KÖŞELİ KİLİTLİ SAKLAMA KABI 4'Ü SET / RECTANGLE LOCKED CONTAINER 4 PCS. SET	1,7+2,7+4,6+8,2 LT.	0,968	12 SET	11,616	12,23	485 x 370 x 860	0,154	SLEEVE CARD BOX	8697422301604

STORAGE BOX

FRESH SAKLAMA SET FRESH STORAGE BOX SET



F012

DESIGN CODE : X133 | FLORA
FRESH SAKLAMA KABI SET | FRESH STORAGE BOX SET



DESENLER | DESIGNS

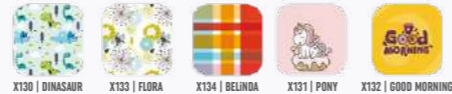

FRESH SAKLAMA KAPLARI | FRESH STORAGE BOX SETS

ÜRÜN KODU PRODUCT CODE	ÜRÜN ADI AÇIKLAMA PRODUCT NAME	KAPASİTE CAPACITY LT.	TEK ÜRÜN AĞIRLIĞI PRODUCT WEIGHT	KOLİ İÇİ ADET PCS IN BOX	KOLİ NET NET WEIGHT	KOLİ BRÜT GROSS W.	KOLİ EBATİ BOX DIMENSIONS (MM)	KOLİ m ³ BOX m ³	AMBALAJ ŞEKLİ PACKING TYPE	BARKOD EAN 13 CODE
F012	FRESH SAKLAMA KABI SETİ / FRESH STORAGE BOX SETS	0,3+0,45+0,65+1 LT.	0,192	24 SET	4,61	5,03	425 x 285 x 270	0,032	COLOR BOX	8697422307385

LİMONLUKLAR LEMON SQUEEZERS



L023



DESIGN CODE : X 135 | YEŞİL LİMON | GREEN LEMON



DESIGN CODE : X 136 | HAYVANLAR | ANIMALS



DESIGN CODE : X 62 | LİMON | LEMON



L024



DESIGN CODE : X 24 | BEYAZ | WHITE



DESIGN CODE : X 67 | SARI | YELLOW

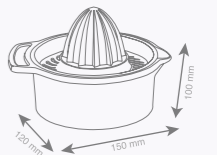

L023 | L024

LİMONLUKLAR | LEMONS SQUEEZERS

ÜRÜN KODU PRODUCT CODE	ÜRÜN ADI AÇIKLAMA PRODUCT NAME	KAPASİTE CAPACITY LT.	TEK ÜRÜN AĞIRLIĞI PRODUCT WEIGHT	KOLİ İÇİ ADET PCS IN BOX	KOLİ NET NET WEIGHT	KOLİ BRÜT GROSS W.	KOLİ EBATİ BOX DIMENSIONS (MM)	KOLİ m ³ BOX m ³	AMBALAJ ŞEKLİ PACKING TYPE	BARKOD EAN 13 CODE
L023	DESENLİ LİMON & PORTAKAL SIKACAĞI / DECO LEMON & ORANGE SQUEEZER	-	0,059	48	2,83	4,21	517 x 415 x 420	0,09	SHRINK BOX	8697422302236
L024	LİMON & PORTAKAL SIKACAĞI / LEMON & ORANGE SQUEEZER	-	0,059	48	2,83	4,09	395 x 310 x 500	0,061	SLEEVE CARD BOX	8697422302298

ÇOK AMAÇLI SÜZGEÇ SETİ

MULTI-PURPOSE COLANDER & BOWL SET

S099



DESIGN CODE : X 73 | KIRMIZI | RED



DESIGN CODE : X 72 | YEŞİL | GREEN



DESIGN CODE : X 25 | MOR | PURPLE

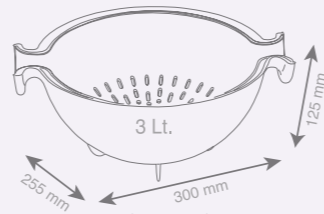

S099

ÇOK AMAÇLI SÜZGEÇ | MULTI-PURPOSE COLANDER & BOWL SET

ÜRÜN KODU PRODUCT CODE	ÜRÜN ADI AÇIKLAMA PRODUCT NAME	KAPASİTE CAPACITY LT.	TEK ÜRÜN AĞIRLIĞI PRODUCT WEIGHT	KOLİ İÇİ ADET PCS IN BOX	KOLİ NET NET WEIGHT	KOLİ BRÜT GROSS W.	KOLİ EBATLARI BOX DIMENSIONS (MM)	KOLİ m ³ BOX m ³	AMBALAJ ŞEKLİ PACKING TYPE	BARKOD EAN 13 CODE
S099	ÇOK AMAÇLI SÜZGEÇ & KASE SETİ / MULTI-PURPOSE COLANDER & BOWL SET	3 LT.	0,333	24	8	8,8	620 x 530 x 315	0,1	SLEEVE CARD BOX	8697422302533

ÇEKMECE TİPİ KAŞIKLIKLAR

WIDE SIZE CUTLERY

C009



DESIGN CODE : X 89 | ŞEFFAF | CLEAR

DESIGN CODE : X 101S
ŞEFFAF SİYAH | CLEAR BLACK

C008



DESIGN CODE : X 69 | MAVİ | BLUE



DESIGN CODE : X 38 | GRİ | GRAY



DESIGN CODE : X 24 | BEYAZ | WHITE

ÇEKMECE TİPİ KAŞIKLIK | WIDE SIZE CUTLERY

ÜRÜN KODU PRODUCT CODE	ÜRÜN ADI AÇIKLAMA PRODUCT NAME	KAPASİTE CAPACITY LT.	TEK ÜRÜN AĞIRLIĞI PRODUCT WEIGHT	KOLİ İÇİ ADET PCS IN BOX	KOLİ NET NET WEIGHT	KOLİ BRÜT GROSS W.	KOLİ EBATLARI BOX DIMENSIONS (MM)	KOLİ m ³ BOX m ³	AMBALAJ ŞEKLİ PACKING TYPE	BARKOD EAN 13 CODE
C009	ŞEFFAF ÇEKMECE TİPİ KAŞIKLIK / WIDE SIZE CUTLERY CLEAR	-	0,384	24	7,68	8,28	445 x 395 x 355	0,06	BOX	8697422307361
C008	ÇEKMECE TİPİ KAŞIKLIK / WIDE SIZE CUTLERY	-	0,384	24	7,68	8,28	445 x 395 x 355	0,06	BOX	8697422307354

ÇİZGİLİ SMART BULAŞIKLIK LINE SMART DISH DRAINER

DESENLİ ve METALİZE SMART BULAŞIKLIK DECO and METALLIC SMART DISH DRAINER



CZ012 **NEW**



DESIGN CODE : X 86 | SİYAH | BLACK



DESIGN CODE : X 38 | GRİ | GRAY



DESIGN CODE : X 161 | KUM BEJİ | SAND BEIGE



DESIGN CODE : X 24 | BEYAZ | WHITE

SMART BULAŞIKLIKLAR | SMART DISH DRAINERS

ÜRÜN KODU PRODUCT CODE	ÜRÜN ADI AÇIKLAMA PRODUCT NAME	KAPASİTE CAPACITY LT.	TEK ÜRÜN AĞIRLIĞI PRODUCT WEIGHT	KOLİ İÇİ ADET PCS IN BOX	KOLİ NET NET WEIGHT	KOLİ BRÜT GROSS W.	KOLİ EBATLARI BOX DIMENSIONS (MM)	KOLİ m ³ BOX m ³	AMBALAJ ŞEKLİ PACKING TYPE	BARKOD EAN 13 CODE
CZ012	ÇİZGİLİ SMART BULAŞIKLIK LINE SMART DISH DRAINER	-	0,619	12	7,42	8,12	510 x 380 x 565	0,11	BOX	8697422308238
T019	SMART DESENLİ BULAŞIKLIK SMART DECO DISH DRAINER	-	0,62	12	6,96	7,66	510 x 380 x 565	0,11	BOX	8697422308009
T020	SMART METALİZE BULAŞIKLIK SMART METALLIC DISH DRAINER	-	0,62	12	6,96	7,66	510 x 380 x 565	0,11	BOX	8697422308016



T019 **NEW**



DESIGN CODE : X 129 | SİYAH MERMER | BLACK MARBLE



DESIGN CODE : X 140 | FOOD | FOOD



DESIGN CODE : X 128 | BEYAZ MERMER | WHITE MARBLE

T020 **NEW**



DESIGN CODE : X 158 | DOMINO METALİZE | DOMINO METALLIC



DESIGN CODE : X 13 | SADE METALİZE | PLAIN METALLIC



BULAŞIKLIKLAR / PİKNIK SEPETLERİ

T042

ÖRGÜ DOKUSU
KNIT EMBOSS

DESIGN CODE : X 21 | KREM | CREAM

DESIGN CODE : X 24 | BEYAZ | WHITE

D060

DESIGN CODE : X 13 | SADE METALİZE | PLAIN METALLIC

Parmak izi bırakmaz
No fingerprint

PASLANMAZ
NO RUST

Çökük oluşmaz
No dent

Silenebilir
Easy to clean

N012

PETEK DOKUSU
HONEYCOMB EMBOSS

DESIGN CODE : X 21 | KREM | CREAM

DESIGN CODE : X 24 | BEYAZ | WHITE

T032

DANTELLİ DOKUSU
LACY EMBOSS

DESIGN CODE : X 24 | BEYAZ | WHITE

DESIGN CODE : X 21 | KREM | CREAM

BULAŞIKLIKLAR ve PİKNIK SEPETLERİ | DISH DRAINERS and PICNIC BASKETS

ÜRÜN KODU PRODUCT CODE	ÜRÜN ADI AÇIKLAMA PRODUCT NAME	KAPASİTE CAPACITY LT.	TEK ÜRÜN AĞIRLIĞI PRODUCT WEIGHT	KOLİ İÇİ ADET PCS IN BOX	KOLİ NET NET WEIGHT	KOLİ BRÜT GROSS W.	KOLİ EBATLARI BOX DIMENSIONS (MM)	KOLİ m ³ BOX m ³	AMBALAJ ŞEKLİ PACKING TYPE	BARKOD EAN 13 CODE
D059	DESENLİ BULAŞIKLIK / DECO DISH DRAINER	-	0,741	20	14,82	16	525 x 435 x 675	0,15	BOX	8697422301611
D060	METALİZE BULAŞIKLIK / METALLIC DISH DRAINER	-	0,74	20	14,8	16	525 x 435 x 675	0,15	BOX	8697422301628
T042	ÖRGÜ BULAŞIKLIK / KNIT DISH DRAINER	-	0,77	20	15,4	16,58	525 x 435 x 675	0,15	BOX	8697422302304
T032	DANTELLİ BULAŞIKLIK / LACY DISH DRAINER	-	0,73	20	14,6	15,9	525 x 435 x 675	0,15	BOX	8697422301857
N012	PETEK BULAŞIKLIK / HONEYCOMB DISH DRAINER	-	0,757	20	15,14	16,44	525 x 435 x 675	0,15	BOX	8697422303363
D032	DESENLİ PİKNIK SEPETİ / DECO PICNIK BASKET	24,5 LT.	0,909	12	10,908	11,76	510 x 380 x 565	0,127	BOX	8697422301222

DISH DRAINERS / PICNIC BASKETS



D059

DESIGN CODE : X 118
VINTAGE LAVANTA | VINTAGE LAVANDER

DESIGN CODE : X 140 | FOOD | FOOD

DESIGN CODE : X 128 | BEYAZ MERMER | WHITE MARBLE

DESIGN CODE : X 04 | TAŞ | STONE

DESIGN CODE : X 139 | ICE CREAM

DESIGN CODE : X 129 | SİYAH MERMER | BLACK MARBLE

D032

DESIGN CODE : X 129
SİYAH MERMER | BLACK MARBLE

DESIGN CODE : X 128
BEYAZ MERMER | WHITE MARBLE

DESIGN CODE : X 137
PEOPLE

DESIGN CODE : X 138
MORNING

KATLI BULAŞIKLIK



DOUBLE LAYER DISH DRAINER

T006



DESIGN CODE : X 89 | ŞEFFAF | CLEAR

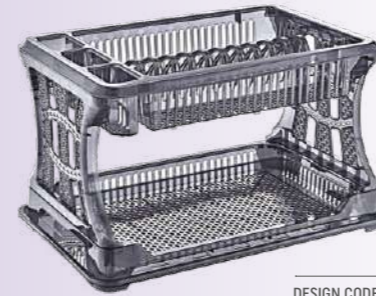

DESIGN CODE : X 101S
ŞEFFAF SİYAH
CLEAR BLACK

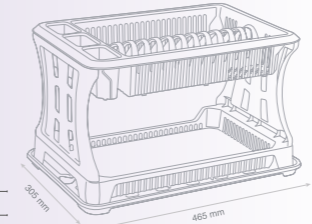

T005 | T006

TRANSPARENT

T005



DESIGN CODE : X 73 | KIRMIZI | RED



DESIGN CODE : X 23 | KAHVE | BROWN



DESIGN CODE : X 38 | GRİ | GRAY



DESIGN CODE : X 24 | BEYAZ | WHITE

DOUBLE LAYER DISH DRAINER

PETEK DOKULU KATLI BULAŞIKLIK | HONEYCOMB EMOSS DOUBLE LAYER DISH DRAINER

ÜRÜN KODU PRODUCT CODE	ÜRÜN ADI AÇIKLAMA PRODUCT NAME	KAPASİTE CAPACITY LT.	TEK ÜRÜN AĞIRLIĞI PRODUCT WEIGHT	KOLİ İÇİ ADET PCS IN BOX	KOLİ NET NET WEIGHT	KOLİ BRÜT GROSS W.	KOLİ EBATLARI BOX DIMENSIONS (MM)	KOLİ m ³ BOX m ³	AMBALAJ ŞEKLİ PACKING TYPE	BARKOD EAN 13 CODE
T005	PETEK KATLI BULAŞIKLIK / HONEYCOMB DOUBLE LAYER DISH DRAINER	-	0,846	12	10,152	10,932	605 x 460 x 590	0,16	BOX	8697422303523
T006	PETEK KATLI BULAŞIKLIK ŞEFFAF/HONEYCOMB DOUBLE LAYER DISH DRAINER TRANSPARENT	-	0,846	12	10,152	10,932	605 x 460 x 590	0,16	BOX	8697422307392

KESİM PANOLARI



K040



DESIGN CODE : X 38 - X 67 | GRI & SARI | GRAY & YELLOW



DESIGN CODE : X 24 - X 73 | BEYAZ & KIRMIZI | WHITE & RED



DESIGN CODE : X 24 - X 38 | GRI & BEYAZ | GRAY & WHITE

KAYMAZ ÇİFT RENKLİ KESİM PANOSU LOGOLU | NON-SLIP DOUBLE-COLOR CHOPPING BOARD WITH LOGO

ÜRÜN KODU PRODUCT CODE	ÜRÜN ADI AÇIKLAMA PRODUCT NAME	TEK ÜRÜN AĞIRLIĞI PRODUCT WEIGHT	KOLİ İÇİ ADET PCS IN BOX	KOLİ NET NET WEIGHT	KOLİ BRÜT GROSS W.	KOLİ EBATLARI BOX DIMENSIONS (MM)	KOLİ m ³ BOX m ³	AMBALAJ ŞEKLİ PACKING TYPE	BARKOD EAN 13 CODE
K040	KAYMAZ ÇİFT RENKLİ KESİM PANOSU LOGOLU / NON-SLIP DOUBLE-COLOR CHOPPING BOARD WITH LOGO	0,553	25	13,84	14,14	353 x 263 x 210	0,017	BOX	8697422306706
K014	1 NO KESİM PANOSU / 1 NO CHOPPING BOARD	0,251	25	6,275	6,39	275 x 180 x 185	0,009	BOX	8697422300614
K015	2 NO KESİM PANOSU / 2 NO CHOPPING BOARD	0,349	25	8,725	8,94	320 x 220 x 185	0,013	BOX	8697422300621
K016	3 NO KESİM PANOSU / 3 NO CHOPPING BOARD	0,541	25	12,85	13,1	365 x 275 x 185	0,019	BOX	8697422300638
K017	4 NO KESİM PANOSU / 4 NO CHOPPING BOARD	0,732	20	14,64	14,91	420 x 285 x 165	0,020	BOX	8697422300720
K018	3 NO KAYMAZ KESİM PANOSU / NON-SLIP CHOPPING BOARD NO: 3	0,557	25	13,93	14,1	365 x 280 x 190	0,019	BOX	8697422302458

CHOPPING BOARDS

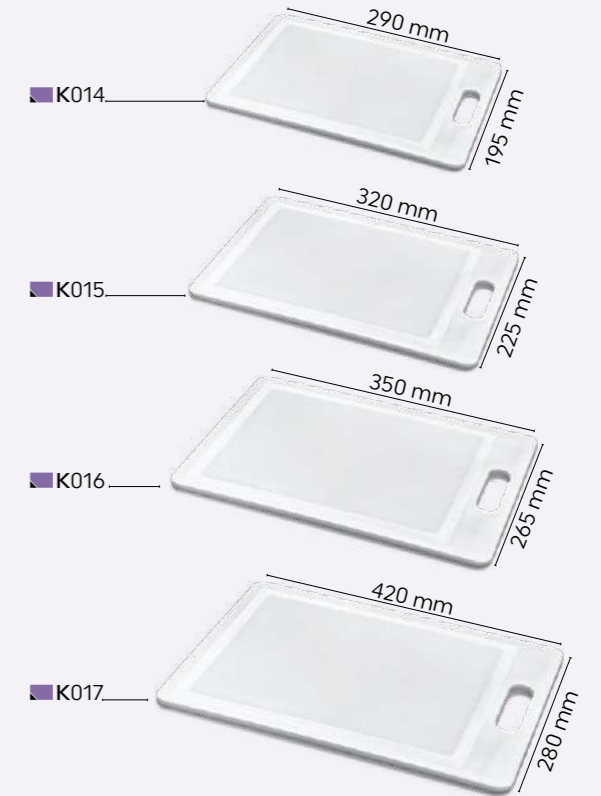

CHOPPING BOARD

K018

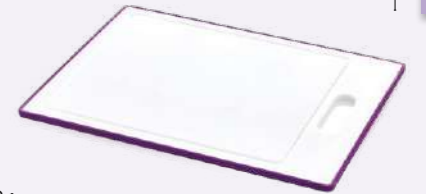

DESIGN CODE : X 25 | MOR | PURPLE



DESIGN CODE : X 73 | KIRMIZI | RED



DESIGN CODE : X 72 | YEŞİL | GREEN

SÜNGERLİKLER SPONGE HOLDERS



D061



DESIGN CODE : X 139 | ICE CREAM



DESIGN CODE : X 140 | FOOD | FOOD



DESIGN CODE : X 128 | BEYAZ MERMER | WHITE MARBLE



DESIGN CODE : X 129 | SIYAH MERMER | BLACK MARBLE



DESIGN CODE : X 04 | TAŞ | STONE



DESIGN CODE : X 118 | VINTAGE LAVANTA | VINTAGE LAVANDER

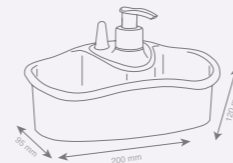

SÜNGERLİK ve SÜRAHI / SPONGE HOLDERS and JUGS

ÜRÜN KODU PRODUCT CODE	ÜRÜN ADI AÇIKLAMA PRODUCT NAME	KAPASİTE CAPACITY LT.	TEK ÜRÜN AĞIRLIĞI PRODUCT WEIGHT	KOLİ İÇİ ADET PCS IN BOX	KOLİ NET NET WEIGHT	KOLİ BRÜT GROSS W.	KOLİ EBATI BOX DIMENSIONS (MM)	KOLİ m ³ BOX m ³	AMBALAJ ŞEKLİ PACKING TYPE	BARKOD EAN 13 CODE
D061	DESENLİ SÜNGERLİK / DECO SPONGE HOLDER WITH DISPENSER	-	0,129	24	3,096	3,7	650 x 300 x 250	0,049	SLEEVE CARD COLOR BOX	8697422301666
S036	ORIENT SÜRAHI / ORIENT CRYSTAL PITCHER	2 LT.	0,287	24	6,88	7,708	575 x 385 x 480	0,106	SHRINK + BOX	8697422302045
S007	OVAAL AYRAN SÜRAHI / OVAL CHURN	2 LT.	0,183	24	3,66	4,32	607 x 387 x 510	0,120	SHRINK + BOX	8697422300263
S008	DESENLİ SÜRAHI / DECO PITCHER	2 LT.	0,183	40	7,32	8,32	750 x 500 x 465	0,174	SHRINK + BOX	8697422300867
S020	RANDOM SÜRAHI / RANDOM PITCHER	2 LT.	0,24	24	6,88	7,708	575 x 385 x 480	0,106	BOX	8697422302144

SÜRAHİLER JUGS

S008



DESIGN CODE : X 128
BEYAZ MERMER | WHITE MARBLE



DESIGN CODE : X 129
SIYAH MERMER | BLACK MARBLE



DESIGN CODE : X 138
MORNING | MORNING



DESIGN CODE : X 137
PEOPLE | PEOPLE



DESIGN CODE : X 04
TAŞ | STONE

S007



S036



ORIENT SÜRAHI
ORIENT CRYSTAL PITCHER

S020



RANDOM ORIENT SÜRAHI
RANDOM CRYSTAL PITCHER

2 LT

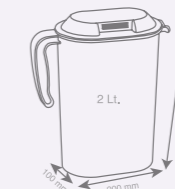

S007 | S008

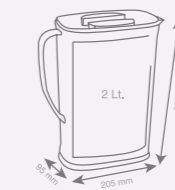

S020 | S036



05



BEBEK | ÇOCUK ÜRÜNLERİ
BABY | CHILD ACCESSORIES

RENK ve MUTLULUK
COLORS and HAPPINESS

5'li BEBEK BANYO SETİ

5 PCS BABY BATH SET



C027



DESIGN CODE : X 14
HAYVANLI | ANIMALS

DESIGN CODE : X 80
MARIN | MARINE

DESIGN CODE : X 41
ARABALAR | CARS

PACK TYPE

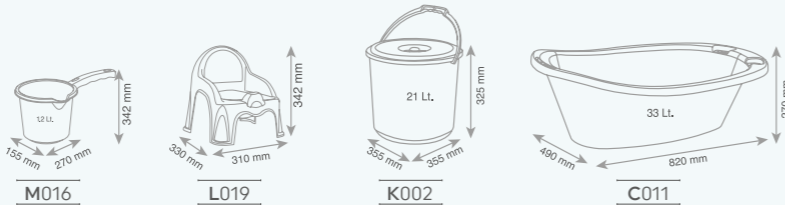

C027



DESIGN CODE : X 40
PERİ | FAIRY

C005

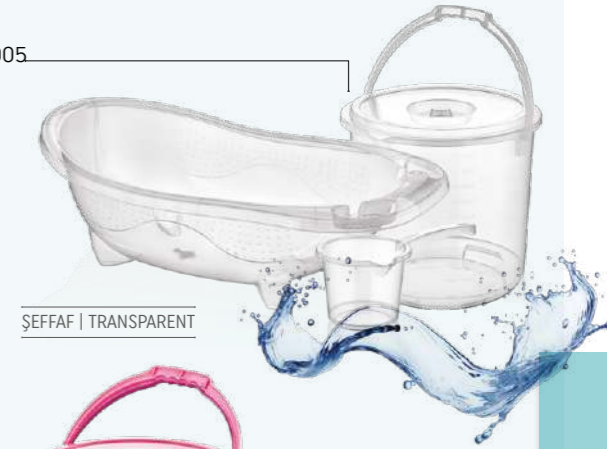

ŞEFFAF | TRANSPARENT



DESIGN CODE : X 16
PRENSES | PRINCESS



DESIGN CODE : X 41
ARABALAR | CARS



DESIGN CODE : X 15
OKYANUS | OCEAN

BEBEK BANYO SETİ / BABY BATH SET

ÜRÜN KODU PRODUCT CODE	ÜRÜN ADI AÇIKLAMA PRODUCT NAME	KAPASİTE CAPACITY LT.	TEK ÜRÜN AĞIRLIĞI PRODUCT WEIGHT	KOLİ İÇİ ADET PCS IN BOX	KOLİ NET NET WEIGHT	KOLİ BRÜT GROSS W.	KOLİ EBATİ BOX DIMENSIONS (MM)	KOLİ m ³ BOX m ³	AMBALAJ ŞEKLİ PACKING TYPE	BARKOD EAN 13 CODE
C027	BEBEK BANYO SETİ (5 PRÇ.) - DEMONTE / BABY BATH SET (5 PCS.) - DEMONTE	-	2,382	1 SET	2,382	2,382	-	0,032	BULK	8697422301536
C027	BEBEK BANYO SETİ (5 PRÇ.) / BABY BATH SET (5 PCS.)	-	2,382	1 SET	2,382	2,382	820 x 490 x 360	0,145	COLOR BOX	8697422301536
C005	TIPALI 3'ÜŞÜ SAFİR BEBEK SETİ - DEMONTE / 3 PCS SAPPHIRE BATH SET WHITE DRAINER - DEMONTE	-	1,830	1 SET	1,830	3,43	-	0,032	BULK	8697422307378

5 PCS BABY BATH SET

BEBEK KÜVETLERİ

C011



DESIGN CODE : X 14
HAYVANLI | ANIMALS



DESIGN CODE : X 41
ARABALAR | CARS



DESIGN CODE : X 16
PRENSE | PRINCESS



DESIGN CODE : X 80
MARİN | MARINE



DESIGN CODE : X 40
PERİ | FAIRY



DESIGN CODE : X 15
OKYANUS | OCEAN

KÜVETLER / BATHTUBS

ÜRÜN KODU PRODUCT CODE	ÜRÜN ADI AÇIKLAMA PRODUCT NAME	KAPASİTE CAPACITY LT.	TEK ÜRÜN AĞIRLIĞI PRODUCT WEIGHT	KOLİ İÇİ ADET PCS IN BOX	KOLİ NET NET WEIGHT	KOLİ BRÜT GROSS W.	KOLİ EBATİ BOX DIMENSIONS (MM)	KOLİ m ³ BOX m ³	AMBALAJ ŞEKLİ PACKING TYPE	BARKOD EAN 13 CODE
C011	DESENLİ ÇOCUK KÜVETİ / DECO BATHTUB	33 LT.	0,062	50	53,55	53,55	820 x 490 x 330	0,480	POLY BAG	8697422301291
C001	SAFİR BEBEK KÜVETİ TIPALI / SAPPHIRE BABY BATHTUB WITH DRAINER	39 LT.	1,069	50	53,45	53,45	800 x 490 x 940	0,368	POLY BAG	8697422303424
C002	SAFİR BEBEK KÜVETİ / SAPPHIRE COLORFUL BABY BATHTUB	39 LT.	1,069	50	53,45	53,45	800 x 490 x 940	0,368	POLY BAG	8697422303431
C004	SAFİR RENKLI BEBEK KÜVETİ TIPALI / SAPPHIRE COLORFUL BABY BATHTUB WITH DRAINER	39 LT.	1,069	50	53,45	53,45	800 x 490 x 940	0,368	POLY BAG	8697422303509

BABY BATHTUBS



C004



MAVİ | BLUE

TIPALI
WIHT DRAINER

C002



PEMBE | PINK

C001

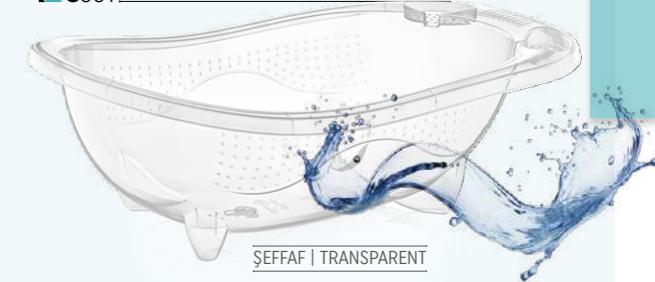

ŞEFFAF | TRANSPARENT

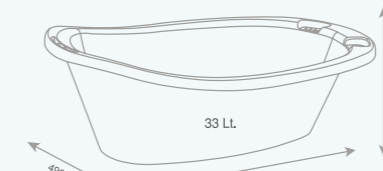
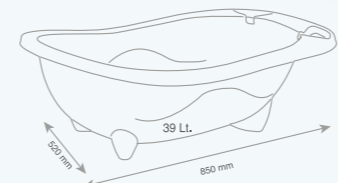

C001 | C002 | C003 | C004

C011



TOMBİK MAMA KOLTUĞU

TOMBİK FEEDING SEAT



OYUN OYNARKEN | PLAYING GAMES



M099



DESIGN CODE : X 147 - X 38
SU ALTI | UNDERWATER



DESIGN CODE : X 145
LUNAPARK | FUN FAIR

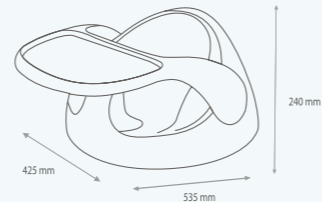

ÜRÜN KODU PRODUCT CODE	ÜRÜN ADI AÇIKLAMA PRODUCT NAME	KAPASİTE CAPACITY LT.	TEK ÜRÜN AĞIRLIĞI PRODUCT WEIGHT	KOLİ İÇİ ADET PCS IN BOX	KOLİ NET NET WEIGHT	KOLİ BRÜT GROSS W.	KOLİ EBATİ BOX DIMENSIONS (MM)	KOLİ m ³ BOX m ³	AMBALAJ ŞEKLİ PACKING TYPE	BARKOD EAN 13 CODE
M099	TOMBİK MAMA KOLTUĞU / TOMBİK FEEDING SEAT	-	1,100	1	1,100	1,480	430 x 250 x 430	0,046	COLOR BOX	8697422307576
M099	TOMBİK MAMA KOLTUĞU - DEMONTE / TOMBİK FEEDING SEAT -DEMONTE	-	1,100	6	6,60	6,98	470 x 430 x 700	0,14	BOX	8697422307576



OFİSTE | OFFICE TIME



MAMA YEDİRİRKEN | AT FEEDING TIME



KOLAY TAŞINABİLİR | EASY TO CARRY

M099



DESIGN CODE : X 147 - X 24
SU ALTI | UNDERWATER



DESIGN CODE : X 146
ÇİFTLİK | FARM



DESIGN CODE : X 144
UNICORN | UNICORN



YAZLIK ORTAMDA | USABLE AT SUMMER



BANYO YAPTIRIRKEN | AT BATH TIME



PIKNİKTE | AT PICNIC TIME

PATİ LAZIMLIK PATI POTTY

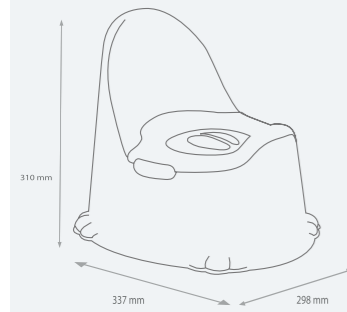

L027



DESIGN CODE : X 150
FİL | ELEPHANT



DESIGN CODE : X 151
PENGUEN | PENGUIN



DESIGN CODE : X 152
PANDA | PANDA



DESIGN CODE : X 148
İNEK | COW



DESIGN CODE : X 149
TILKI | FOX

PATİ LAZIMLIK / PATI POTTY

ÜRÜN KODU PRODUCT CODE	ÜRÜN ADI AÇIKLAMA PRODUCT NAME	KAPASİTE CAPACITY LT.	TEK ÜRÜN AĞIRLIĞI PRODUCT WEIGHT	KOLİ İÇİ ADET PCS IN BOX	KOLİ NET NET WEIGHT	KOLİ BRÜT GROSS W.	KOLİ EBATİ BOX DIMENSIONS (MM)	KOLİ m ³ BOX m ³	AMBALAJ ŞEKLİ PACKING TYPE	BARKOD EAN 13 CODE
L027	PATİ LAZIMLIK / PATI POTTY	-	0,448	12	5,378	5,818	305 x 350 x 602	0,062	BOX	8697422307583

LAZIMLIK ve MAŞRAPALAR POTTIES and BATH PITCHERS

L019



DESIGN CODE : X 40
PERİ | FAIRY



DESIGN CODE : X 41
ARABALAR | CARS



DESIGN CODE : X 80
MARİN | MARINE



DESIGN CODE : X 15
OKYANUS | OCEAN



DESIGN CODE : X 16
PRENSE | PRINCESS



DESIGN CODE : X 14
HAYVANLI | ANIMALS

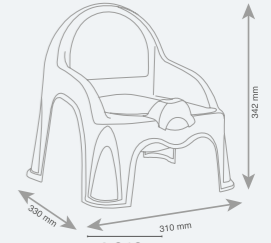

L019

M016



DESIGN CODE : X 41
ARABALAR | CARS



DESIGN CODE : X 80
MARİN | MARINE



DESIGN CODE : X 15
OKYANUS | OCEAN

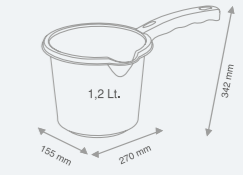

M016



DESIGN CODE : X 16
PRENSE | PRINCESS



DESIGN CODE : X 14
HAYVANLI | ANIMALS



DESIGN CODE : X 40
PERİ | FAIRY

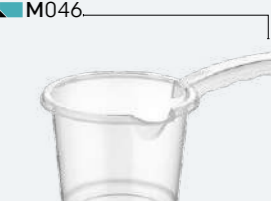

DESIGN CODE : X 89
ŞEFFAF | TRANSPARENT

LAZIMLIKLAR ve MAŞRAPALAR / POTTIES & BABY BATH PITCHERS

ÜRÜN KODU PRODUCT CODE	ÜRÜN ADI AÇIKLAMA PRODUCT NAME	KAPASİTE CAPACITY LT.	TEK ÜRÜN AĞIRLIĞI PRODUCT WEIGHT	KOLİ İÇİ ADET PCS IN BOX	KOLİ NET NET WEIGHT	KOLİ BRÜT GROSS W.	KOLİ EBATİ BOX DIMENSIONS (MM)	KOLİ m ³ BOX m ³	AMBALAJ ŞEKLİ PACKING TYPE	BARKOD EAN 13 CODE
L019	LAZIMLIK / POTTY (WITH COVER)	-	0,474	20	9,48	10,4	665 x 350 x 730	0,170	BOX	8697422301086
M016	BEBEK BANYO MAŞRAPASI / BABY BATH PITCHER	1,2 LT.	0,886	72	6,192	6,54	430 x 275 x 445	0,053	POLY BAG	8697422301925
M046	SAFİR BEBEK BANYO MAŞRAPASI / SAPPHIRE BABY BATH PITCHER	1,2 LT.	0,886	72	6,192	6,54	430 x 275 x 445	0,053	POLY BAG	8697422303448

ÇOCUK OYUNCAĞI KUTUSU ASKILIK ve KATLI BASAMAK

CHILD TOYS BOX / CLOTHES HANGER / DOUBLE STEP STOOL

A007



SB006



20 LT

B003

CHILD TOYS BOX
DOUBLE STEP STOOL

OYUNCAK KUTUSU / ASKI ve KATLI BASAMAK / TOYS BOX / CLOTHES HANGER and DOUBLE STEP STOOL

ÜRÜN KODU PRODUCT CODE	ÜRÜN ADI AÇIKLAMA PRODUCT NAME	KAPASİTE CAPACITY LT.	TEK ÜRÜN AĞIRLIĞI PRODUCT WEIGHT	KOLİ İÇİ ADET PCS IN BOX	KOLİ NET NET WEIGHT	KOLİ BRÜT GROSS W.	KOLİ EBATLARI BOX DIMENSIONS (MM)	KOLİ m ³ BOX m ³	AMBALAJ ŞEKLİ PACKING TYPE	BARKOD EAN 13 CODE
A007	ÇOCUK ELBİSE ASKISI (6'lı) / HANGER FOR CHILD CLOTHES (6 PCS)	-	0,147	240	5,88	6,18	475 x 255 x 345	0,042	BOX	8697422301833
SB006	OYUNCAK KUTUSU / TOYS BOX	20 LT.	0,76	12	9,12	9,77	495 x 330 x 675	0,11	BOX	8697422302076
B003	DESENLI KATLI ÇOCUK BASAMAĞI / DECO CHILD DOUBLE STEP STOOL	-	1,04	12	12,48	12,48	400 x 370 x 740	0,11	BULK	8697422302540

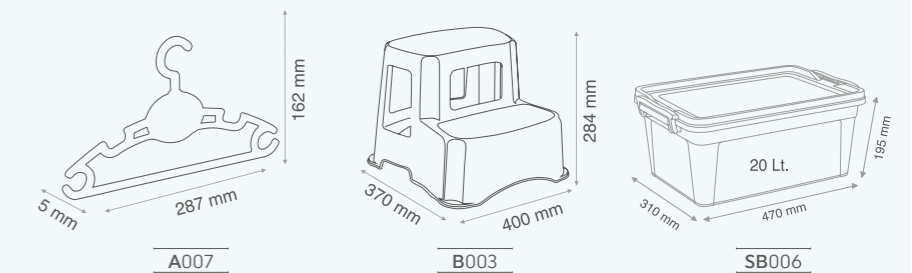

ÇOCUK KOLTUKLARI CHILD CHAIRS

C031



DESIGN CODE : X 69
MAVİ | BLUE



DESIGN CODE : X 67
SARI | YELLOW



DESIGN CODE : X 68
PEMBE | PINK



DESIGN CODE : X 24
BEYAZ | WHITE

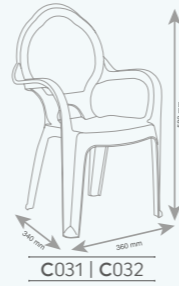

C031 | C032

C032



DESIGN CODE : X 15
OKYANUS | OCEAN



DESIGN CODE : X 14
HAYVANLI | ANIMALS



DESIGN CODE : X 16
PRENSE | PRINCESS



DESIGN CODE : X 40
PERİ | FAIRY



DESIGN CODE : X 41
ARABALAR | CARS

ÇOCUK KOLTUKLARI / CHILD CHAIRS

ÜRÜN KODU PRODUCT CODE	ÜRÜN ADI AÇIKLAMA PRODUCT NAME	KAPASİTE CAPACITY LT.	TEK ÜRÜN AĞIRLIĞI PRODUCT WEIGHT	KOLİ İÇİ ADET PCS IN BOX	KOLİ NET NET WEIGHT	KOLİ BRÜT GROSS W.	KOLİ EBATİ BOX DIMENSIONS (MM)	KOLİ m ³ BOX m ³	AMBALAJ ŞEKLİ PACKING TYPE	BARKOD EAN 13 CODE
C031	HASIR ÇOCUK KOLTUĞU / RATTAN CHILD CHAIR	-	0,606	25	15,15	15,15	360 x 340 x 1300	0,159	BULK	8697422301765
C032	DESENLİ ÇOCUK KOLTUĞU / DECO CHILD CHAIR	-	0,612	25	15,3	15,3	360 x 340 x 1300	0,159	BULK	8697422301772

ÇOCUK KOMODİNLERİ CHILD COMMODES

K012



DESIGN CODE : X 41
ARABALAR | CARS



DESIGN CODE : X 40
PERİ | FAIRY

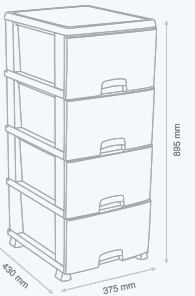

DESENLİ ÇOCUK KOMODİN / DECO CHILD COMMODE

ÜRÜN KODU PRODUCT CODE	ÜRÜN ADI AÇIKLAMA PRODUCT NAME	KAPASİTE CAPACITY LT.	TEK ÜRÜN AĞIRLIĞI PRODUCT WEIGHT	KOLİ İÇİ ADET PCS IN BOX	KOLİ NET NET WEIGHT	KOLİ BRÜT GROSS W.	KOLİ EBATİ BOX DIMENSIONS (MM)	KOLİ m ³ BOX m ³	AMBALAJ ŞEKLİ PACKING TYPE	BARKOD EAN 13 CODE
K012	DESENLİ ÇOCUK KOMODİN / DECO CHILD COMMODE	-	4,87	1	4,87	5,03	395 x 420 x 410	0,069	SHRINK	8697422303479





ÖZ-ER PLASTİK SAN. ve TİC. LTD. ŞTİ.

Merkez & İhracat Departmanı | Head Office & Export Department

İstoç 11. Ada No : 18 - 20 Bağcılar - İSTANBUL / TÜRKİYE

Tel : +90 (212) 659 00 32

Fax : +90 (212) 659 16 52

e-mail : info@ozerplastik.com

Fabrika | Factory

Çakmaklı Akçaburgaz Mah. Akçaburgaz Cad. No : 54

Esenyurt / İSTANBUL - TÜRKİYE

Tel : +90 (212) 886 94 94 (pbx)

Fax : +90 (212) 886 94 96

e-mail : export@ozerplastik.com

