

ozer[®]



2023 - 2024 ürün katalogu

2023 - 2024 product catalog

SINCE 1969

kalite belgelerimiz Quality certificates



Firmamız Mısır GOEIC
İhracat Sistemine
Kayıtlıdır.
Our Company Has Registration
For Export To Egypt According
To GOEIC System.



Hakkımızda

Kendi sektörünün öncü ve lider firmalarından biri olan ÖZ-ER Plastik; 1969 yılında Mahmut ÖZER tarafından kurulmuştur. Kurulduğundan bu yana plastik ev eşyaları üretmektedir. İstanbul'da 13.000 m² kapalı alanda üretimini gerçekleştiren firmanın ürün yelpazesine sürekli yeni ürünler eklenmektedir. Gelişen teknolojiye ayak uydurarak kaliteli ve yeni üretim araçlarıyla dekoratif ürünlerin imal edildiği firma ayrıca, yurt içi ve yurt dışı piyasasında büyük bir pazar payına sahiptir.

About Us

OZ-ER Plastics is one of the prominent and leading firms in its own sector. Since its establishment in 1969 by Mahmut ÖZER, firm has been manufacturing plastic housewares. Firm has 13.000 m² factory area and new products are added to its scale periodically. Keeping up with the current technology, firm manufactures decorative products with new production equipments of high quality, while it has a big share in national and international markets.

4-17

Banyo
aksesuarları
**Bathroom
accessories**

18-45

Genel
kullanım
**General
usage**

46-55

Temizlik
grubu
**Cleaning
accessories**

56-67

Mutfak
ürünleri
**Kitchen
products**

68-80

Bebek/Çocuk
ürünleri
**Baby/Child
accessories**

01

**banyo
aksesuarlari**

bathroom
accessories



estetik ve kolaylık
aesthetic and convenience

Petek Dokulu Honeycomb Emboss

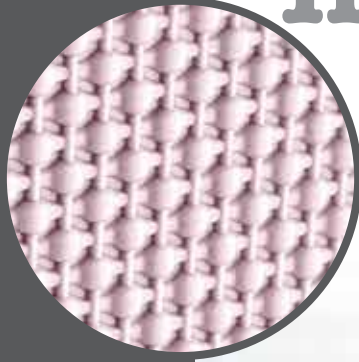

N008

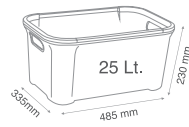

D079



N009

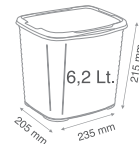

N010

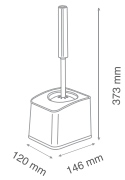

N011

Banyo Serisi Bathroom Collection



NEW

N013
Design Code: X38
Gri / Grey



N013
Design Code: X24
Beyaz / White



N013
Design Code: X21
Krem / Cream



N013
Design Code: X112
Rose / Rose



N013
Design Code: X88
Violet / Violet



PACK TYPE

5 PARÇA PETEK BANYO SETİ HONEYCOMB BATH SET 5 PCS.

ÜRÜN
KOD
PRODUCT
CODE

ÜRÜN ADI / AÇIKLAMA
PRODUCT NAME

KAPASİTE
CAPACITY
LT.

TEK ÜRÜN
AĞIRLIĞI
PRODUCT
WEIGHT

KOLİ ÇADET
PCS IN BOX

KOLİ NET
NET WEIGHT

KOLİ BRÜT
GROSS W.

KOLİ BOYUTU
BOX
DIMENSIONS
(MM)

KOLİ M³
BOX M³

PAKETLEME
SEKİLİ
PACKING
TYPE

BARKOD
EAN 13
CODE

N013

5 Parça Petek Banyo Seti / Honeycomb Bath Set 5 Pcs



3,1

1SET

3,1

3,86

470x370x580

0,1

COLOR BOX

869742230 338 7

Petek Dokulu Honeycomb Emboss



N008
Design Code: X112
Rose / Rose



N008
Design Code: X24
Beyaz / White



N008
Design Code: X21
Krem / Cream



N008
Design Code: X38
Gri / Grey



N008
Design Code: X88
Violet / Violet



D079
Design Code: X112
Rose / Rose



D079
Design Code: X21
Krem / Cream



D079
Design Code: X88
Violet / Violet



D079
Design Code: X24
Beyaz / White



D079
Design Code: X38
Gri / Grey



N015
Design Code: X112
Rose / Rose



N015
Design Code: X21
Krem / Cream



N015
Design Code: X88
Violet / Violet



N015
Design Code: X24
Beyaz / White



N015
Design Code: X38
Gri / Grey

PETEK DOKULU ÜRÜNLER

HONEYCOMB EMBOSS PRODUCTS

ÜRÜN KOD PRODUCT CODE	ÜRÜN ADI / AÇIKLAMA PRODUCT NAME	KAPASİTE CAPACITY LT.	TEK ÜRÜN AĞIRLIĞI PRODUCT WEIGHT	KOLİ ÇADET PCS IN BOX	KOLİ NET NET WEIGHT	KOLİ BRÜT GROSS WL.	KOLİ BOYUTU BOX DIMENSIONS (MM)	KOLİ M ³ BOX M ³	PAKETLEME SEKİLİ PACKING TYPE	BARKOD EAN 13 CODE
D079	Petek Köşeli Sepet / Honeycomb Rectangle Basket	25 Lt.	0,758	20	15,16	15,16	485x335x1120	0,18	BULK	869742230 256 4
N008	Petek Kirli Çamaşır Sepeti Ve Kapak / Honeycomb Laundry Basket & Cover	63 Lt.	1,387	6	8,32	9,52	470x370x1015	0,176	BULK	869742230 332 5
N010	Petek Deterjanlık / Petek Kılık Çöp Kovası	6,2 Lt.	0,349	24	8,37	8,9	475x415x535	0,105	BOX	869742230 334 9
N009	Petek Çöp Kovası / Honeycomb Click Bin	6,2 Lt.	0,377	24	9,05	9,59	465x390x595	0,108	BOX	869742230 333 2
N011	Petek Köşeli Wc Fırçası / Honeycomb Rect. Wc Brush		0,188	24	4,51	5,12	610x390x410	0,1	BOX	869742230 335 6
N015	Büyük Petek Seke / Big Honeycomb Clothes Basket	32 Lt.	0,637	20	12,74	12,74	545x325x1230	0,218	BULK	869742230 704 0

Banyo Ürünleri Bathroom Products



N011
Design Code: X112
Rose / Rose



N011
Design Code: X24
Beyaz / White



N011
Design Code: X21
Krem / Cream



N011
Design Code: X38
Gri / Grey



N011
Design Code: X88
Violet / Violet



N009
Design Code: X112
Rose / Rose



N009
Design Code: X24
Beyaz / White



N009
Design Code: X21
Krem / Cream



N009
Design Code: X38
Gri / Grey



N009
Design Code: X88
Violet / Violet



N010
Design Code: X112
Rose / Rose



N010
Design Code: X24
Beyaz / White



N010
Design Code: X21
Krem / Cream



N010
Design Code: X38
Gri / Grey



N010
Design Code: X88
Violet / Violet



N008

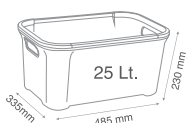

D079

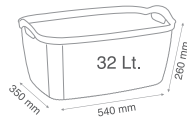

N015

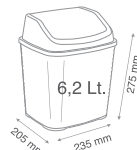

N009

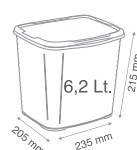

N010

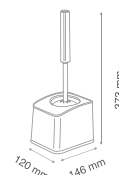

N011

Örgü Dokulu Knit Emboss



O007
Design Code: X21
Krem / Cream



O007
Design Code: X23
Kahve / Brown



O007
Design Code: X24
Beyaz / White



PACK TYPE



O001



O003

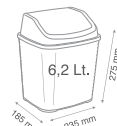

O005



O004

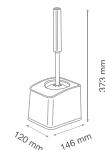

O006

Banyo Serisi Bathroom Collection



O003
Design Code: X23
Kahve / Brown



O003
Design Code: X21
Krem / Cream



O003
Design Code: X24
Beyaz / White



O001
Design Code: X23
Kahve / Brown



O005
Design Code: X23
Kahve / Brown



O005
Design Code: X21
Krem / Cream



O005
Design Code: X24
Beyaz / White



O001
Design Code: X21
Krem / Cream



O004
Design Code: X23
Kahve / Brown



O004
Design Code: X21
Krem / Cream



O004
Design Code: X24
Beyaz / White



O006
Design Code: X23
Kahve / Brown



O006
Design Code: X21
Krem / Cream



O006
Design Code: X24
Beyaz / White



O001
Design Code: X24
Beyaz / White

ÖRGÜ DOKULU ÜRÜNLER KNIT PRODUCTS

ÜRÜN KOD PRODUCT CODE	ÜRÜN ADI / AÇIKLAMA PRODUCT NAME	KAPASİTE CAPACITY LT.	TEK ÜRÜN AĞIRLIĞI PRODUCT WEIGHT	KOLİ İÇ ADET PCS IN BOX	KOLİ NET AĞIRLIĞI NET WEIGHT	KOLİ BRÜT AĞIRLIĞI GROSS WL.	KOLİ BOYUTU BOX DIMENSIONS (MM)	KOLİ M ³ BOX M ³	PAKETLEME ŞEKLİ PACKING TYPE	BARKOD EAN 13 CODE
O003	Örgü Köşeli Sepeti / Knit Rectangle Basket	25 Lt.	0,773	20	15,46	15,46	485x335x1120	0,18	BULK	869742230 231 1
O005	Örgü Klık Çöp Kovası / Knit Click Bin	6,2 Lt.	0,391	24	9,38	9,92	465x390x595	0,108	BOX	869742230 247 2
O004	Örgü Deterjanlık / Knit Detergent Box	6,2 Lt.	0,342	24	8,2	8,73	475x415x535	0,105	BOX	869742230 246 5
O006	Örgü Köşeli Wc / Knit Rectangle Wc Brush		0,185	24	4,44	5,05	610x390x415	0,099	BOX	869742230 249 6
O001	Örgü Kirli Çamaşır Sepeti ve Kapak / Knit Laundry Basket & Cover	48 Lt.	1,35	6	8,1	9,1	430x350x840	0,126	BOX	869742230 212 0
P028	Dantelli Kirli Çamaşır Sepeti ve Kapak / Lacy Laundry Basket & Cover	48 Lt.	1,39	12	16,68	17	430x350x1850	0,278	BULK	869742230 199 4
O007	5 Parça Örgü Banyo Seti / Knit Bath Set 5 Pcs		3,069	1 SET	3,069	3,809	482x333x545	0,087	BOX	869742230 250 2

Dalga Dokulu Banyo Serisi Wavy Emboss Bathroom Collection



L037
Design Code: X38
Gri / Grey



L037
Design Code: X92
Lacivert / Navy



L037
Design Code: X24
Beyaz / White



L037
Design Code: X161
Kum Beji / Sand Beige

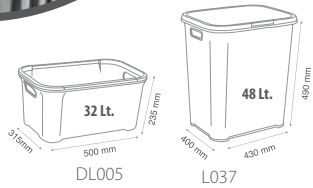
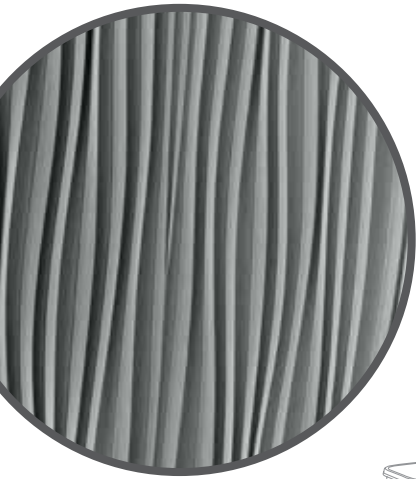

DL005
Design Code: X38
Gri / Grey



DL005
Design Code: X92
Lacivert / Navy



DL005
Design Code: X24
Beyaz / White



DL005
Design Code: X161
Kum Beji / Sand Beige

DALGA DOKULU ÜRÜNLER WAVY PRODUCTS

ÜRÜN KOD PRODUCT CODE	ÜRÜN ADI / AÇIKLAMA PRODUCT NAME	KAPASİTE CAPACITY LT.	TEK ÜRÜN AĞIRLIĞI PRODUCT WEIGHT	KOLİ İÇ ADET PCS IN BOX	KOLİ NET NET WEIGHT	KOLİ BRÜT GROSS WL.	KOLİ BOYUTU BOX DIMENSIONS (MM)	KOLİ M ³ BOX M ³	PAKETLEME ŞEKLİ PACKING TYPE	BARKOD EAN 13 CODE
L037	Dalgalı Kirlili Çamaşır Sepeti / Wavy Laundry Hamper	48 Lt.	1,52 kg	12	18,24 kg	18,24 kg	335x420x1415	0,19	POLY BAG	869742230 799 6
DL005	Dalgalı Çamaşır Sepeti / Wavy Clothes Basket	32 Lt.	0,55 kg	20	11 kg	11 kg	339x500x1131	0,19	BULK	869742230 804 7

Desenli Banyo Serisi Go Go Bathroom Collection

D053

Design Code: X128
Beyaz Mermer / White Marble



D053

Design Code: X129
Siyah Mermer / Black Marble



D053

Design Code: X75
Parke / Parquet



D053

Design Code: X04
Taş / Stone



DESENLİ 9'LU BANYO SETİ 9 PCS GO GO BATHROOM SET

ÜRÜN
KOD
PRODUCT
CODE

ÜRÜN ADI / AÇIKLAMA
PRODUCT NAME

KAPASİTE
CAPACITY
LT.

TEK ÜRÜN
AĞIRLIĞI
PRODUCT
WEIGHT

KOLUÇ ADET
PCS IN BOX

KOLU NET
NET WEIGHT

KOLU BRÜT
GROSS W.

KOLU BOYUTU
BOX
DIMENSIONS (MM)

KOLU M³
BOX M³

PAKETLEME
SEKİLİ
PACKING
TYPE

BARKOD
EAN13
CODE

D053 Desenli 9'lu Banyo Seti Demonte / 9 Pcs Go Go Bathroom Set - Demonte

D053 Desenli 9'lu Banyo Seti / 9 Pcs Go Go Bathroom Set

2,45

1 SET

2,45

3,1

420x340x520

0,073

COLOR BOX

869742230 140 6

869742230 140 6

Desenli ve Metalize Go Go and Metallic



D0013
Design Code: X13
Sade Metalize / Plain Metallic



D0012
Design Code: X137
People / People

NEW



D0012
Design Code: X129
Siyah Mermer / Black Marble



D0012
Design Code: X138
Morning / Morning

NEW



D0012
Design Code: X128
Beyaz Mermer / White Marble



D0012
Design Code: X04
Taş / Stone



D0012
Design Code: X118
Vintage Lavanta /
Vintage Lavander



D0012
Design Code: X75
Parke / Parquet

KİRLİ CAMAŞIR SEPETLERİ / DETERJANLIK VE KÜÇÜK DETERJANLIKLAR / BANYO LAVABO SETLERİ

LAUNDRY BASKETS / DETERGENT AND SMALL DETERGENTS / BATHROOM SINK SETS

ÜRÜN KODU PRODUCT CODE	ÜRÜN ADI / AÇIKLAMA PRODUCT NAME	KAPASİTE CAPACITY LT.	TEK ÜRÜN AĞIRLIĞI PRODUCT WEIGHT	KOLİ İÇİ ADET PCS IN BOX	KOLİ NET AĞIRLIĞI NET WEIGHT	KOLİ BRÜT AĞIRLIĞI GROSS WL.	KOLİ BOYUTU BOX DIMENSIONS (MM)	KOLİ M ³ BOX M ³	PAKETLEME SEKİLİ PACKING TYPE	BAR KOD EAN 13 CODE
D0012	Desenli Oval Kirli Çamaşır Sepeti ve Kapak / Go Go Oval Laundry Basket & Cover	41 Lt.	1,184	10	11,84	12,96	435x340x1070	0,158	BOX	869742230 112 3
D0012	Desenli Oval Kirli Çamaşır Sepeti ve Kapak - Demonte / Go Go Oval Laundry Basket & Cover - Demonte	41 Lt.	1,184	25	29,6	29,6		0,330	BULK	869742230 112 3
D015	Desenli Deterjanlık / Go Go Detergent Box	6,9 Lt.	0,322	24	7,728	8,35	625x370x435	0,101	BOX	869742230 094 2
D016	Desenli Kalgonluk / Go Go Calgon Box	2,2 Lt.	0,161	48	7,728	8,3	450x425x455	0,087	BOX	869742230 096 6
D046	Desenli 3'lü Banyo Lavabo Seti / 3 Pcs Go Go Bathroom Sink Set		0,144	24	3,456	4,06	513x455x300	0,070	BOX	869742230 131 4
D050	Desenli Sıvı Sabunluk / Go Go Liquid Soap Dispenser	0,5 Lt.	0,069	12	0,828	1,08	330x310x185	0,019	BOX	869742230 145 1
D051	Desenli Katı Sabunluk / Go Go Soap Dish		0,027	60	1,62	1,83	305x200x195	0,012	BOX	869742230 144 4
D052	Desenli Diş Fırçalık / Go Go Tooth Brush Holder		0,044	18	0,792	1	335x235x225	0,018	BOX	869742230 146 8
D076	Desenli 3'lü Banyo Lavabo Seti / 3 Pcs Go Go Bathroom Sink Set VAKUM AMBALAJ		0,21	36	7,56	8,43	570x470x670	0,180	BOX	869742230 345 5

Kirli Çamaşır Sepetleri / Deterjanlıklar/ Lavabo Setleri Laundry Baskets / Detergent Box/Sink Sets

6,9
LT

D015

Design Code: X04
Taş / Stone

D015

Design Code: X75
Parke / Parquet

D015

Design Code: X129
Siyah Mermer / Black Marble

D015

Design Code: X128
Beyaz Mermer / White Marble2,2
LT

D016

Design Code: X04
Taş / Stone

D016

Design Code: X04
Taş / Stone

D016

Design Code: X129
Siyah Mermer / Black Marble

D016

Design Code: X128
Beyaz Mermer / White Marble

D046

Design Code: X75
Parke / Parquet

D046

Design Code: X04
Taş / Stone

D046

Design Code: X129
Siyah Mermer / Black Marble

D046

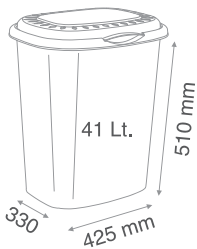
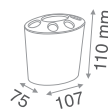
Design Code: X128
Beyaz Mermer / White MarbleD0012
D0013D015
D033D016
D034

D052



D050

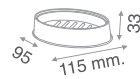

D051

Desenli ve Metalize Go Go and Metallic



Raflara her türlü banyo duş malzemelerinizi koyabilirsiniz. Banyo köşeliği ile beraber verilen dübel ve vida ile banyonuzun köşesine, matkap yardımıyla sağlam şekilde asabilirsiniz. En alt kısımdaki kancalara, asılabilecek banyo malzemelerinizi güvenli şekilde asabilirsiniz.

Every kind of shower stuff (shampoo, soap, blade etc), could be put on shelves

Thanks to plastic dowel and screw (attached to product), you can hang the Corner Shelf easily and safely with the help of drill.

Your shower accesories like sponges, washing clothes etc. could be hanged to the hooks at the bottom side.

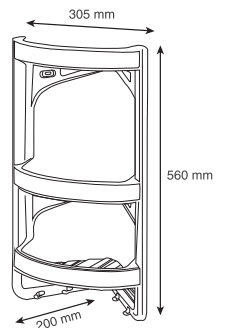

Banyo Köşelikleri Bath Corner Shelf

**B009**Design Code: X69
Mavi / Blue**B009**Design Code: X21
Krem / Cream**B009**Design Code: X24
Beyaz / White**B010**Design Code: X128
Beyaz Mermer /
White Marble**B010**Design Code: X129
Siyah Mermer /
Black Marble**B011**Design Code: X111
Karbon Metalik /
Carbon Metallic**B011**Design Code: X13
Siyah Sade Metal /
Black Body Plain Metallic**B011**Design Code: X13
Beyaz Sade Metal /
White Body Plain Metallic

Video

**BANYO KÖŞELİKLERİ****BATH CORNER SHELF**

ÜRÜN KOD PRODUCT CODE	ÜRÜN ADI / AÇIKLAMA PRODUCT NAME	KAPASİTE CAPACITY LT.	TEK ÜRÜN AĞIRLIĞI PRODUCT WEIGHT	KOLİ ÇADET PCS IN BOX	KOLİ NET NET WEIGHT	KOLİ BRÜT GROSS W.	KOLİ BOYUTU BOX DIMENSIONS (MM)	KOLİ M ³ BOX M ³	PAKETLEME SEKİLİ PACKING TYPE	BARKOD EAN 13 CODE
B009	Banyo Köşeliği / Bathroom Corner Shelf		0,38	12	4,56	5,14	490x310x550	0,084	BOX	869742230 748 4
B010	Desenli Banyo Köşeliği / Go Go Bathroom Corner Shelf		0,38	12	4,56	5,14	490x310x550	0,084	BOX	869742230 749 1
B011	Metalize Banyo Köşeliği / Metallic Bathroom Corner Shelf		0,38	12	4,56	5,14	490x310x550	0,084	BOX	869742230 750 7

02

**genel
kullanım**

general
usage



pratik ve sıklık
practical and classiness

Desenli 3 Pcs Deco



PACK TYPE

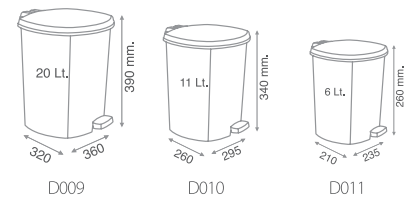

3'lü Pedallı Çöp Kovası Setleri Step Bin Sets



3 BOY DESENLİ PEDALLI ÇÖP KOVASI SET 3 PCS GO GO STEP BIN SET

ÜRÜN KOD PRODUCT CODE	ÜRÜN ADI / AÇIKLAMA PRODUCT NAME	KAPASİTE CAPACITY LT.	TEK ÜRÜN AĞIRLIĞI PRODUCT WEIGHT	KOLİ ÇADET PCS IN BOX	KOLİ NET NET WEIGHT	KOLİ BRÜT GROSS W.	KOLİ BOYUTU BOX DIMENSIONS (MM)	KOLİ M ³ BOX M ³	PAKETLEME ŞEKLİ PACKING TYPE	BARKOD EAN 13 CODE
D044	3 Boy Desenli Pedallı Çöp Kovası Set / 3 Pcs Go Go Step Bin Set	6+11+20 Lt.	3,250	1 SET	3,250	3,686	340x330x402	0,045	COLOR BOX	869742230 123 9

Desenli ve Metalize Deco and Metallic

NEW



D009

Desing Code:X153
Parke / Parquet

D009

Desing Code:X153
Tropical / Tropical

D009

Design Code: X48
Deri / Leather

D009

Design Code: X04
Taş / Stone

D009

Design Code: X118
Vintage Lavanta / Vintage Lavander

D009

Design Code: X129
Siyah Mermer / Black Marble20
LT

NEW



D010

Design Code: X75
Parke / Parquet

D010

Desing Code:X153
Tropical / Tropical

D010

Design Code: X48
Deri / Leather

D010

Design Code: X04
Taş / Stone

D010

Design Code: X118
Vintage Lavanta / Vintage Lavander

D010

Design Code: X129
Siyah Mermer / Black Marble11
LT

NEW



D011

Design Code: X75
Parke / Parquet

D011

Desing Code:X153
Tropical / Tropical

D011

Design Code: X48
Deri / Leather

D011

Design Code: X04
Taş / Stone

D011

Design Code: X118
Vintage Lavanta / Vintage Lavander

D011

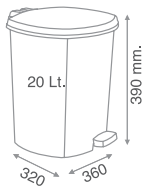
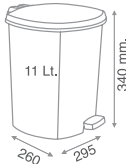
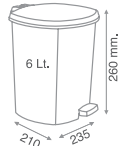
Design Code: X129
Siyah Mermer / Black Marble6
LTD009
D002D010
D003D011
D004

PACK TYPE



DESENLİ PEDALLI ÇÖP KOVALARI GO GO STEP BINS

ÜRÜN KOD PRODUCT CODE	ÜRÜN ADI / AÇIKLAMA PRODUCT NAME	NAPASİTE CAPACITY LT.	TEK ÜRÜN AĞIRLIĞI PRODUCT WEIGHT	KOLİ ÇADET PCS IN BOX	KOLİ NET NET WEIGHT	KOLİ BRÜT GROSS W.	KOLİ BOYUTU BOX DIMENSIONS (MM)	KOLİ M ³ BOX M ³	PAKETLEME ŞEKLİ PACKING TYPE	BARKOD EAN 13 CODE
D009	4 No Desenli Pedallı Çöp Kovası / Go Go Step Bin No:4	20 Lt.	1,576	4	6,304	7,48	675x640x400	0,173	BOX	869742230 186 4
D010	3 No Desenli Pedallı Çöp Kovası / Go Go Step Bin No:3	11 Lt.	0,924	8	7,392	8,32	540x520x670	0,188	BOX	869742230 187 1
D011	2 No Desenli Pedallı Çöp Kovası / Go Go Step Bin No:2	6 Lt.	0,574	12	6,888	7,67	660x425x525	0,147	BOX	869742230 188 8
D002	4 No Metalize Köşeli Çöp Kovası / Metallic Step Bin No:4	20 Lt.	1,576	4	6,304	7,48	675x640x400	0,173	BOX	869742230 099 7
D003	3 No Metalize Köşeli Çöp Kovası / Metallic Step Bin No:3	11 Lt.	0,924	8	7,392	8,32	540x520x670	0,188	BOX	869742230 098 0
D004	2 No Metalize Köşeli Çöp Kovası / Metallic Step Bin No:2	6 Lt.	0,574	12	6,888	7,67	660x425x525	0,147	BOX	869742230 097 3

Pedallı Çöp Kovaları Step Bins



D009
Design Code: X128
Beyaz Mermer / White Marble



D009 **NEW**
Design Code: X138
Morning / Morning



D009 **NEW**
Design Code: X137
People / People



D009 **NEW**
Design Code: X154
Yaprak / Leaf



D002
Design Code: X13
Sade Metalize / Plain Metallic



D002
Design Code: X111
Karbon Metalize / Carbon Metallic

20 LT



D010
Design Code: X128
Beyaz Mermer / White Marble



D010 **NEW**
Design Code: X138
Morning / Morning



D010 **NEW**
Design Code: X137
People / People



D010 **NEW**
Design Code: X154
Yaprak / Leaf



D003
Design Code: X13
Sade Metalize / Plain Metallic



D003
Design Code: X111
Karbon Metalize / Carbon Metallic

11 LT



D011
Design Code: X128
Beyaz Mermer / White Marble



D011 **NEW**
Design Code: X138
Morning / Morning



D011 **NEW**
Design Code: X137
People / People



D011 **NEW**
Design Code: X154
Yaprak / Leaf



D004
Design Code: X13
Sade Metalize / Plain Metallic



D004
Design Code: X111
Karbon Metalize / Carbon Metallic

6 LT



D045
Design Code: X13
Sade Metalize / Plain Metallic



D045
Design Code: X111
Karbon Metalize / Carbon Metallic

NEW

3 BOY METALİZE ÇÖP KOVASI SET 3 PCS METALLIC STEP BIN SET

ÜRÜN KODU PRODUCT CODE	ÜRÜN ADI / AÇIKLAMA PRODUCT NAME	KAPASİTE CAPACITY LT.	TEK ÜRÜN AĞIRLIĞI PRODUCT WEIGHT	KOLİ İÇİ ADET PCS IN BOX	KOLİ NET AĞIRLIĞI NET WEIGHT	KOLİ BRÜT AĞIRLIĞI GROSS W.	KOLİ BOYUTU BOX DIMENSIONS (MM)	KOLİ M ³ BOX M ³	PAKETLEME ŞEKLİ PACKING TYPE	BARKOD EAN 13 CODE
D045	3 Boy Metalize Pedallı Çöp Kovası Set / 3 Pcs. Metallic Step Bin Set	6+11+20 Lt.	3,288	1 SET	3,288	3,724	340x330x402	0,045	COLOR BOX	869742230 143 7

Sade / Desenli / Metalize Plain / Go Go / Metallic

NEW



D095
Design Code: X38
Gri / Grey

50 LT



D095
Design Code: X24
Beyaz / White



D095
Design Code: X21
Krem / Cream

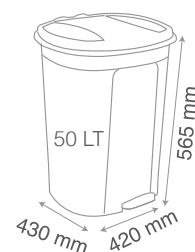

Grande Çöp Kovaları 50 LT

Grande Step Bins 50 LT

NEW

D096

 Design Code: X129
 Siyah Mermer / Black Marble

D096

 Design Code: X128
 Beyaz Mermer / White Marble

D096

 Design Code: X138
 Morning / Morning

D096

 Design Code: X137
 People / People

Video

D097

 Design Code: X13
 Sade Metal / Plain Metallic

D097

 Design Code: X111
 Karbon Metalize / Carbon Metallic

50 LT

SADE/DESENLİ/METALİZE GRANDE ÇÖP KOVALARI PLAIN/GO GO/METALLIC STEP BINS

ÜRÜN KODU PRODUCT CODE	ÜRÜN ADI / AÇIKLAMA PRODUCT NAME	KAPASİTE CAPACITY LT.	TEK ÜRÜN AĞIRLIĞI PRODUCT WEIGHT	KOLİ ÇADET PCS IN BOX	KOLİ NET NET WEIGHT	KOLİ BRÜT GROSS WL	KOLİ BOYUTU BOX DIMENSIONS (MM)	KOLİ M ³ BOX M ³	PAKETLEME SEKİLİ PACKING TYPE	BARKOD EAN 13 CODE
D095	Grande Pedal Çöp Kovası - Demonte / Grande Pedal Bin - Demonte	50 Lt.	3	4	12	12,8	450x450x960	0,19	BOX	869742230 751 4
D096	Desenli Grande Pedal Çöp Kovası - Demonte / Go Go Grande Pedal Bin - Demonte	50 Lt.	3,3	4	13,2	14	450x450x960	0,19	BOX	869742230 752 1
D097	Metalize Grande Pedal Çöp Kovası - Demonte / Metallic Grande Pedal Bin - Demonte	50 Lt.	3,3	4	13,2	14	450x450x960	0,19	BOX	869742230 754 5
D095	Grande Pedal Çöp Kovası / Grande Pedal Bin	50 Lt.	3	1	3	3,7	435x435x580	0,109	BOX	869742230 751 4
D096	Desenli Grande Pedal Çöp Kovası / Go Go Grande Pedal Bin	50 Lt.	3,3	1	3,3	4	435x435x580	0,109	BOX	869742230 752 1
D097	Metalize Grande Pedal Çöp Kovası / Metallic Grande Pedal Bin	50 Lt.	3,3	1	3,3	4	435x435x580	0,109	BOX	869742230 754 5

Hasır Pedallı Çöp Kovaları

Rattan Step Bins

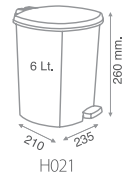
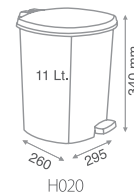
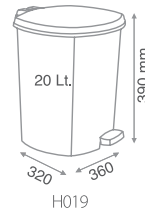

HASIR ÇÖP KOVALARI 3 SIZE RATTAN STEP BINS

ÜRÜN KODU PRODUCT CODE	ÜRÜN ADI / AÇIKLAMA PRODUCT NAME	KAPASİTE CAPACITY LT.	TEK ÜRÜN AĞIRLIĞI PRODUCT WEIGHT	KOLU ÇADET PCS IN BOX	KOLU NET AĞIRLIK NET WEIGHT	KOLU BRÜT AĞIRLIK GROSS W.	KOLU BOYUTU BOX DIMENSIONS (MM)	KOLU M ³ BOX M ³	PAKETLEME ŞEKLİ PACKING TYPE	BARKOD EAN 13 CODE
H008	3 Boy Hasır Pedallı Çöp Kovası Set / 3 Pcs. Rattan Step Bin Set	6+11+20 Lt.	3,05	1 SET	3,05	3,59	340x330x405	0,044	COLOR BOX	869742230 193 2
H022	3 Boy Dantelli Pedallı Çöp Kovası Set / 3 Pcs. Lacy Step Bin Set	6+11+20 Lt.	3,129	1 SET	3,129	3,49	340x330x405	0,044	COLOR BOX	869742230 197 0
H002	2 No Hasır Pedallı Çöp / Rattan Step Bin No:2	6 Lt.	0,543	12	6,516	7,22	660x425x525	0,147	BOX	869742230 182 6
H003	3 No Hasır Pedallı Çöp / Rattan Step Bin No:3	11 Lt.	0,948	8	7,584	8,66	540x520x670	0,188	BOX	869742230 181 9
H004	4 No Hasır Pedallı Çöp / Rattan Step Bin No:4	20 Lt.	1,559	4	6,236	7,24	675x640x400	0,173	BOX	869742230 180 2
H019	4 No Dantelli Pedallı Çöp / Lacy Step Bin No:4	20 Lt.	1,559	4	6,236	7,24	675x640x400	0,173	BOX	869742230 194 9
H020	3 No Dantelli Pedallı Çöp / Lacy Step Bin No:3	11 Lt.	0,918	8	7,344	8,45	540x520x670	0,188	BOX	869742230 195 6
H021	2 No Dantelli Pedallı Çöp / Lacy Step Bin No:2	6 Lt.	0,649	12	7,788	8,48	660x425x525	0,147	BOX	869742230 196 3

Slim Metalize Çöp Kovaları

Slim Metallic Step Bins

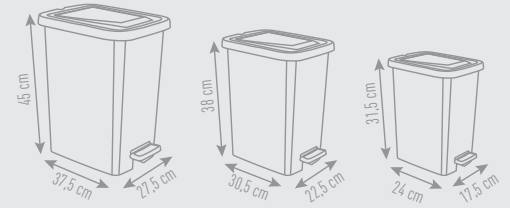
NEW

SLİM METALİZE PEDALLI ÇÖP KOVALARI SLIM METALLIC STEP BINS

ÜRÜN KODU PRODUCT CODE	ÜRÜN ADI / AÇIKLAMA PRODUCT NAME	KAPASİTE CAPACITY LT.	TEK ÜRÜN AĞIRLIĞI PRODUCT WEIGHT	KOLİ ÇADET PCS IN BOX	KOLİ NET AĞIRLIĞI NET WEIGHT	KOLİ BRÜT AĞIRLIĞI GROSS WT.	KOLİ BOYUTU BOX DIMENSIONS (MM)	KOLİ M ³ BOX M ³	PAKETLEME ŞEKLİ PACKING TYPE	BARKOD EAN 13 CODE
S102	25 Lt. Slim Metalize Pedallı Çöp Kovası / 25 Lt. Slim Metallic Step Bin	25 Lt.	2,02 kg	4	8,60 kg	9,13 kg	560x390x690	0,15	BOX	869742230 766 8
S102-1	25 Lt. Slim Metalize Pedallı Çöp Kovası (İç Kovasız) / 25 Lt. Slim Metallic Step Bin(Without Inner Bucket)	25 Lt.	1,24 kg	4	4,96 kg	5,50 kg	560x390x545	0,12	BOX	869742230 780 4
S112	15 Lt. Slim Metalize Pedallı Çöp Kovası / 15 Lt. Slim Metallic Step Bin	15 Lt.	1,26 kg	6	7,6 kg	8,51 kg	700x325x610	0,13	BOX	869742230 783 5
S112-1	15 Lt. Slim Metalize Pedallı Çöp Kovası (İç Kovasız) / 15 Lt. Slim Metallic Step Bin(Without Inner Bucket)	15 Lt.	0,795 kg	6	4,77 kg	5,4 kg	700x325x485	0,11	BOX	869742230 786 6
S122	8 Lt. Slim Metalize Pedallı Çöp Kovası / 8 Lt. Slim Metallic Step Bin	8 Lt.	0,715 kg	12	8,58 kg	9,28 kg	550x535x520	0,15	BOX	869742230 789 7
S122-1	8 Lt. Slim Metalize Pedallı Çöp Kovası (İç Kovasız) / 8 Lt. Slim Metallic Step Bin(Without Inner Bucket)	8 Lt.	0,458 kg	12	5,50 kg	5,80 kg	550x530x415	0,12	BOX	869742230 792 7

Slim Pedallı Çöp Kovaları

Slim Step Bins



NEW

S100 - With Inner Bucket
S103 - Without Inner Bucket



S110 - With Inner Bucket
S113 - Without Inner Bucket

S130
Design Code: X72
Yeşil & Gri / Green & Grey

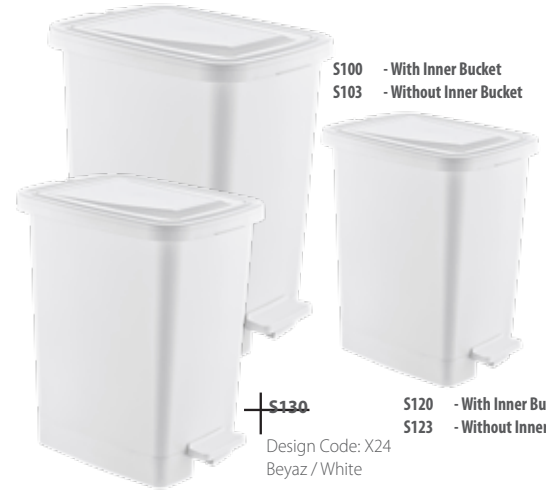

S100 - With Inner Bucket
S103 - Without Inner Bucket

S130
Design Code: X24
Beyaz / White

S110 - With Inner Bucket
S113 - Without Inner Bucket

S120 - With Inner Bucket
S123 - Without Inner Bucket



S100 - With Inner Bucket
S103 - Without Inner Bucket

S130
Design Code: X38
Gümüş & Gri / Silver & Grey

S110 - With Inner Bucket
S113 - Without Inner Bucket

S120 - With Inner Bucket
S123 - Without Inner Bucket

SLİM PEDALLI ÇÖP KOVALARI SLİM METALLIC STEP BINS

ÜRÜN KOD PRODUCT CODE	ÜRÜN ADI / AÇIKLAMA PRODUCT NAME	KAPASİTE CAPACITY LT.	TEK ÜRÜN AĞIRLIĞI PRODUCT WEIGHT	KOLİ ÇADET PCS IN BOX	KOLİ NET AĞIRLIĞI NET WEIGHT	KOLİ BRÜT AĞIRLIĞI GROSS WT.	KOLİ BOYUTU BOX DIMENSIONS (MM)	KOLİ M ³ BOX M ³	PAKETLEME ŞEKLİ PACKING TYPE	BARKOD EAN 13 CODE
--------------------------	-------------------------------------	-----------------------------	-------------------------------------	--------------------------	---------------------------------	---------------------------------	---------------------------------------	---	---------------------------------	-----------------------

S100	25 Lt. Slim Pedallı Çöp Kovası / 25 Lt. Slim Step Bin	25 Lt	1,98 kg	4	7,84 kg	9,02 kg	560x390x690	0,15	BOX	869742230 764 4
S103	25 Lt. Slim Pedallı Çöp Kovası (İç Kovasız) / 25 Lt. Slim Step Bin(Without Inner Bucket)	25 Lt	1,14 kg	4	4,56 kg	5,13 kg	560x390x545	0,12	BOX	869742230 767 5
S110	15 Lt. Slim Pedallı Çöp Kovası / 15 Lt. Slim Step Bin	15 Lt	1,26 kg	6	7,6 kg	8,51 kg	700x325x610	0,13	BOX	869742230 781 1
S113	15 Lt. Slim Pedallı Çöp Kovası (İç Kovasız) / 15 Lt. Slim Step Bin(Without Inner Bucket)	15 Lt	0,795 kg	6	4,77 kg	5,4 kg	700x325x485	0,11	BOX	869742230 784 2
S120	8 Lt. Slim Pedallı Çöp Kovası / 8 Lt. Slim Step Bin	8 Lt	0,715 kg	12	8,58 kg	9,28 kg	550x535x520	0,15	BOX	869742230 787 3
S123	8 Lt. Slim Pedallı Çöp Kovası (İç Kovasız) / 8 Lt. Slim Step Bin(Without Inner Bucket)	8 Lt	0,458 kg	12	5,50 kg	5,80 kg	550x530x415	0,12	BOX	869742230 790 3

Slim Desenli Pedallı Çöp Kovaları

Slim Deco Step Bins

NEW

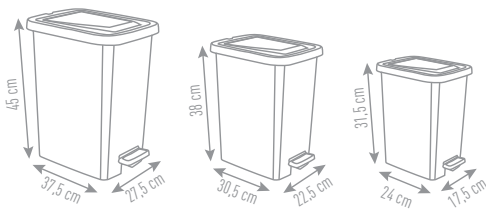

Slim Desenli Pedallı Çöp Kovaları

Slim Deco Step Bins



S101 - With Inner Bucket
S101-1 - Without Inner Bucket

S121 - With Inner Bucket
S121-1 - Without Inner Bucket

S131
Design Code: X138
Morning

S111 - With Inner Bucket
S111-1 - Without Inner Bucket



S101 - With Inner Bucket
S101-1 - Without Inner Bucket

S121 - With Inner Bucket
S121-1 - Without Inner Bucket

S131
Design Code: X137
People

S111 - With Inner Bucket
S111-1 - Without Inner Bucket



S101 - With Inner Bucket
S101-1 - Without Inner Bucket

S121 - With Inner Bucket
S121-1 - Without Inner Bucket

S131
Design Code: X129
Siyah Mermer / Black Marble

S111 - With Inner Bucket
S111-1 - Without Inner Bucket



S101 - With Inner Bucket
S101-1 - Without Inner Bucket

S121 - With Inner Bucket
S121-1 - Without Inner Bucket

S131
Design Code: X128
Beyaz Mermer / White Marble

S111 - With Inner Bucket
S111-1 - Without Inner Bucket

SLİM DESENLİ PEDALLI ÇÖP KOVALARI SLİM DECO STEP BINS

ÜRÜN KODU PRODUCT CODE	ÜRÜN ADI/AÇIKLAMA PRODUCT NAME	KAPASİTE CAPACITY LT.	TEK ÜRÜN AĞIRLIĞI PRODUCT WEIGHT	KOLİ ÇADET PCS IN BOX	KOLİ NET AĞIRLIĞI NET WEIGHT	KOLİ BRÜT AĞIRLIĞI GROSS WL	KOLİ BOYUTU BOX DIMENSIONS (MM)	KOLİ M ³ BOX M ³	PAKETLEME ŞEKLİ PACKING TYPE	BARKOD EAN 13 CODE
S101	25 Lt. Slim Desenli Pedallı Çöp Kovası / 25 Lt. Slim Deco Step Bin	25 Lt	2,02 kg	4	8,60 kg	9,14 kg	560x390x690	0,15	BOX	869742230 765 1
S101-1	25 Lt. Slim Desenli Pedallı Çöp Kovası (İç Kovası)/ 25 Lt. Slim Deco Step Bin(Without Inner Bucket)	25 Lt	1,26 kg	4	5,04 kg	5,59 kg	560x390x545	0,12	BOX	869742230 779 8
S111	15 Lt. Slim Desenli Pedallı Çöp Kovası / 15 Lt. Slim Deco Step Bin	15 Lt	1,26 kg	6	7,6 kg	8,51 kg	700x325x610	0,13	BOX	869742230 782 8
S111-1	15 Lt. Slim Desenli Pedallı Çöp Kovası (İç Kovası)/ 15 Lt. Slim Deco Step Bin(Without Inner Bucket)	15 Lt	0,795 kg	6	4,77 kg	5,4 kg	700x325x485	0,11	BOX	869742230 785 9
S121	8 Lt. Slim Desenli Pedallı Çöp Kovası / 8 Lt. Slim Deco Step Bin	8 Lt	0,715 kg	12	8,58 kg	9,28 kg	550x535x520	0,15	BOX	869742230 788 0
S121-1	8 Lt. Slim Desenli Pedallı Çöp Kovası (İç Kovası)/ 8 Lt. Slim Deco Step Bin(Without Inner Bucket)	8 Lt	0,458 kg	12	5,50 kg	5,80 kg	550x530x415	0,12	BOX	869742230 788 0

Dalgalı Pedallı Çöp Kovaları

Wavy Step Bins

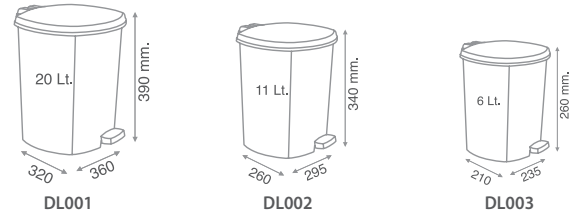

DALGALI PEDALLI ÇÖP KOVALARI WAVY STEP BINS

ÜRÜN KODU PRODUCT CODE	ÜRÜN ADI / AÇIKLAMA PRODUCT NAME	KAPASİTE CAPACITY LT.	TEK ÜRÜN AĞIRLIĞI PRODUCT WEIGHT	KOLİ ÇADDETİ PCS IN BOX	KOLİ NET AĞIRLIĞI NET WEIGHT	KOLİ BRÜT AĞIRLIĞI GROSS WL.	KOLİ BOYUTU BOX DIMENSIONS (MM)	KOLİ M ³ BOX M ³	PAKETLEME ŞEKLİ PACKING TYPE	BARKOD EAN 13 CODE
DL004	3'Lü Dalgalı Pedallı Çöp Kovası Set / Wavy 3 Pcs. Step Bin Set	20 Lt + 11 Lt + 6 Lt	3,31 kg	1 Set	3,27 kg	3,67 kg	335x335x400	0,05	COLOR BOX	869742230 812 2
DL001	4 No Dalgalı Pedallı Çöp Kovası / Wavy Step Bin No:4	20 Lt	1,7 kg	6	10,2 kg	11,3 kg	960x645x410	0,25	BOX	869742230 809 2
DL002	3 No Dalgalı Pedallı Çöp Kovası / Wavy Step Bin No:3	11 Lt	0,99 kg	12	11,88 kg	13,42 kg	785x520x690	0,29	BOX	869742230 810 8
DL003	2 No Dalgalı Pedallı Çöp Kovası / Wavy Step Bin No:2	6 Lt	0,62 kg	12	7,44 kg	8,38 kg	620x420x535	0,15	BOX	869742230 811 5

Desenli Klik Çöp Kovaları Deco and Click Bins



D055
Design Code: X75
Parke / Parquet



D055
Design Code: X04
Taş / Stone



D055
Design Code: X129
Siyah Mermer / Black Marble



D055
Design Code: X128
Beyaz Mermer / White Marble



D013
Design Code: X75
Parke / Parquet



D013
Design Code: X04
Taş / Stone



D013
Design Code: X129
Siyah Mermer / Black Marble



D013
Design Code: X128
Beyaz Mermer / White Marble

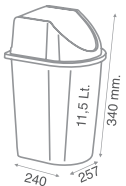

D014
D019

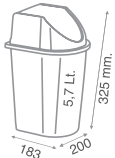

D013
D024

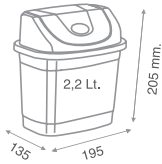

D055
D056

DESENLİ KLİK ÇÖP KOVALARI GO GO AND CLICK BINS

ÜRÜN KODU PRODUCT CODE	ÜRÜN ADI / AÇIKLAMA PRODUCT NAME	KAPASİTE CAPACITY LT.	TEK ÜRÜN AĞIRLIĞI PRODUCT WEIGHT	KOLUÇ ADETİ PCS IN BOX	KOLU NET AĞIRLIĞI NET WEIGHT	KOLU BRÜT AĞIRLIĞI GROSS WL.	KOLU BOYUTU BOX DIMENSIONS (MM)	KOLU M ³ BOX M ³	PAKETLEME ŞEKLİ PACKING TYPE	BARKOD EAN 13 CODE
D013	1 No Desenli Klik Çöp Kovası / 1 No Go Go Click Bin	5,7 Lt.	0,332	24	7,968	8,7	750x415x420	0,131	BOX	869742230 092 8
D055	0 No Desenli Klik Çöp Kovası / 0 No Go Go Click Bin	2,2 Lt.	0,186	24	4,464	4,87	430x215x540	0,050	BOX	869742230 168 0
D056	0 No Metalize Klik Çöp Kovası / 0 No Metallic Click Bin	2,2 Lt.	0,192	24	4,608	5,01	430x215x540	0,050	BOX	869742230 169 7
D024	1 No Metalize Klik Çöp Kovası / 1 No Metallic Click Bin	5,7 Lt.	0,329	24	7,896	8,62	750x415x420	0,131	BOX	869742230 110 9

Metalize Metallic

3in
31



METALİZE KLİK ÇÖP KOVALARI / METALLIC CLICK BINS

ÜRÜN KOD PRODUCT CODE	ÜRÜN ADI / AÇIKLAMA PRODUCT NAME	KAPASİTE CAPACITY LT.	TEK ÜRÜN AĞIRLIĞI PRODUCT WEIGHT	KOLİ İÇ ADET PCS IN BOX	KOLİ NET NET WEIGHT	KOLİ BRÜT GROSS VL.	KOLİ BOYUTU BOX DIMENSIONS (MM)	KOLİ M ³ BOX M ³	PAKETLEME ŞEKLİ PACKING TYPE	BARKOD EAN 13 CODE
D083	0 No Metalize Smart Klık Çöp Kovası / 0 No Metallic Smart Click Bin	3,3 Lt.	0,187	24	4,49	4,88	375x305x540	0,062	BOX	869742230 729 3
D084	1 No Metalize Smart Klık Çöp Kovası / 1 No Metallic Smart Click Bin	6 Lt.	0,345	24	8,28	8,87	450x375x655	0,11	BOX	869742230 730 9
D085	2 No Metalize Smart Klık Çöp Kovası / 2 No Metallic Smart Click Bin	11,6 Lt.	0,6	12	7,2	8	565x455x540	0,138	BOX	869742230 731 6
D090	Metal Smart Klık Çöp Kovası 3'lü Set / 3 Pcs Metallic Smart Click Bin Set	3,3 + 6 + 11,6 Lt.	1,13	1	1,13	1,41	285x220x360	0,023	COLOR BOX	869742230 741 5
D093	3 No Metalize Smart Klık Çöp Kovası / 3 No Metallic Smart Click Bin	23 Lt.	1,05	12	12,6	14	710x550x570	0,22	BOX	869742230 742 2

Smart Klik Çöp Kovaları

Smart Click Bins

NEW



PACK TYPE



D083

Design Code: X13
Sade Metalize / Plain Metallic



D083

Design Code: X111
Karbon Metalize / Carbon Metallic

0 NO

3,3
LT



D084

Design Code: X13
Sade Metalize / Plain Metallic



D084

Design Code: X111
Karbon Metalize / Carbon Metallic

1 NO

6
LT



D085

Design Code: X13
Sade Metalize / Plain Metallic



D085

Design Code: X111
Karbon Metalize / Carbon Metallic

2 NO

11,6
LT



D093

Design Code: X13
Sade Metalize / Plain Metallic



D093

Design Code: X111
Karbon Metalize / Carbon Metallic

3 NO

23
LT

Desenli Go Go



NEW



D089

Design Code: X137
People / People

NEW



D089

Design Code: X138
Morning / Morning

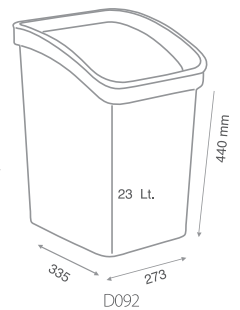
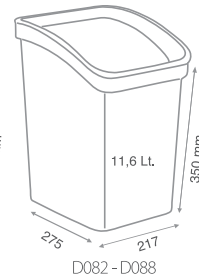
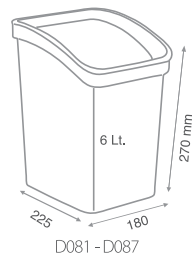
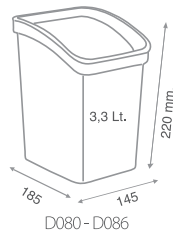

Smart Klik Çöp Kovaları

Smart Click Bins



D089
Design Code: X128
Beyaz Mermer / White Marble

6 LT



D089
Design Code: X83
Paris / Paris

6 LT



D089
Design Code: X129
Siyah Mermer / Black Marble

6 LT



D089
Design Code: X118
Vintage Lavanta / Vintage Lavender

6 LT



D089
Design Code: X75
Parke / Parquet

6 LT

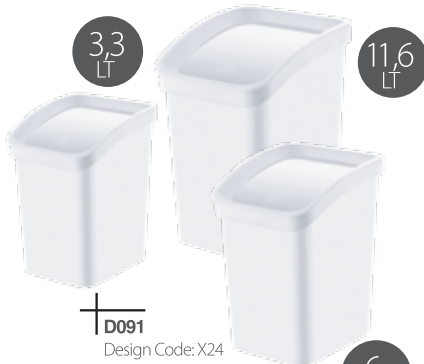

D091
Design Code: X24
Beyaz / White

6 LT



D091
Design Code: X21
Krem / Cream

6 LT

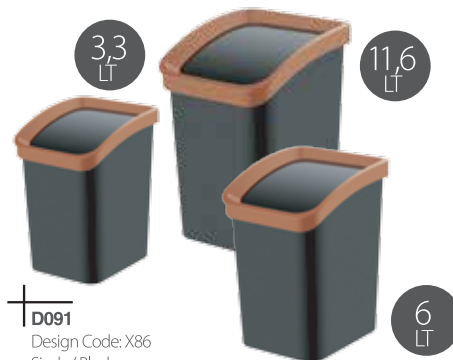

D091
Design Code: X86
Siyah / Black

6 LT

Video



NEW

0 NO

3,3
LT



D080

Design Code: X138
Morning / Morning



D080

Design Code: X137
People / People



D080

Design Code: X129
Siyah Mermer / Black Marble



D080

Design Code: X128
Beyaz Mermer / White Marble



D080

Design Code: X83
Paris / Paris



D080

Design Code: X75
Parke / Parquet



D080

Design Code: X118
Vintage Lavanta /
Vintage Lavander

1 NO

6
LT



D081

Design Code: X138
Morning / Morning



D081

Design Code: X137
People / People



D081

Design Code: X129
Siyah Mermer / Black Marble



D081

Design Code: X128
Beyaz Mermer / White Marble



D081

Design Code: X83
Paris / Paris



D081

Design Code: X75
Parke / Parquet



D081

Design Code: X118
Vintage Lavanta /
Vintage Lavander

2 NO

11,6
LT



D082

Design Code: X138
Morning / Morning



D082

Design Code: X137
People / People



D082

Design Code: X129
Siyah Mermer / Black Marble



D082

Design Code: X128
Beyaz Mermer / White Marble



D082

Design Code: X83
Paris / Paris



D082

Design Code: X75
Parke / Parquet



D082

Design Code: X118
Vintage Lavanta /
Vintage Lavander

DESENLI SMART ÇÖP KOVALARI GO GO SMART CLICK BİN

ÜRÜN KODU PRODUCT CODE	ÜRÜN ADI / AÇIKLAMA PRODUCT NAME	KAPASİTE CAPACITY LT.	TEK ÜRÜN AĞIRLIĞI PRODUCT WEIGHT	KOLİ İÇ ADET PCS IN BOX	KOLİ NET NET WEIGHT	KOLİ BRÜT GROSS W.	KOLİ BOYUTU BOX DIMENSIONS (MM)	KOLİ M ³ BOX M ³	PAKETLEME ŞEKLİ PACKING TYPE	BARKOD EAN 13 CODE
D080	0 No Desenli Smart Klık Çöp Kovası / 0 No Go Go Smart Click Bin	3,3 Lt.	0,187	24	4,49	4,88	375x305x540	0,062	BOX	869742230 726 2
D081	1 No Desenli Smart Klık Çöp Kovası / 1 No Go Go Smart Click Bin	6 Lt.	0,345	24	8,28	8,87	450x375x655	0,11	BOX	869742230 727 9
D082	2 No Desenli Smart Klık Çöp Kovası / 2 No Go Go Smart Click Bin	11,6 Lt.	0,6	12	7,2	8	565x455x540	0,138	BOX	869742230 728 6
D092	3 No Desenli Smart Klık Çöp Kovası / 3 No Go Go Smart Click Bin	23 Lt.	1,05	12	12,6	14	710x550x570	0,22	BOX	869742230 743 9
D086	0 No Smart Klık Çöp Kovası / 0 No Smart Click Bin	3,3 Lt.	0,187	24	4,49	4,88	375x305x540	0,062	BOX	869742230 732 3
D087	1 No Smart Klık Çöp Kovası / 1 No Smart Click Bin	6 Lt.	0,345	24	8,28	8,87	450x375x655	0,11	BOX	869742230 733 0
D088	2 No Smart Klık Çöp Kovası / 2 No Smart Click Bin	11,6 Lt.	0,6	12	7,2	8	565x455x540	0,138	BOX	869742230 734 7
D094	3 No Smart Klık Çöp Kovası / 3 No Smart Click Bin	23 Lt.	1,05	12	12,6	14	710x550x570	0,22	BOX	869742230 734 7
D089	Desenli Smart Klık Çöp Kovası 3'lü Set / 3 Pcs Go Go Smart Click Bin Set	3,3 + 6 + 11,6 Lt.	1,13	1	1,13	1,41	285x220x360	0,023	LOR BOX	869742230 740 8
D091	Smart Klık Çöp Kovası 3'lü Set / 3 Pcs Smart Click Bin Set	3,3 + 6 + 11,6 Lt.	1,13	1	1,13	1,41	285x220x360	0,023	LOR BOX	869742230 742 2

Smart Klik Çöp Kovaları Smart Click Bins



D086
Design Code: X86
Siyah / Black



D086
Design Code: X24
Beyaz / White



D086
Design Code: X21
Krem / Cream

0 NO

3,3
LT



D087
Design Code: X86
Siyah / Black



D087
Design Code: X24
Beyaz / White



D087
Design Code: X21
Krem / Cream

1 NO

6
LT



D088
Design Code: X86
Siyah / Black



D088
Design Code: X24
Beyaz / White



D088
Design Code: X21
Krem / Cream

2 NO

11,6
LT



D094
Design Code: X86
Siyah / Black



D094
Design Code: X24
Beyaz / White



D094
Design Code: X21
Krem / Cream

3 NO

23
LT



D092
Design Code: X138
Morning / Morning



D092
Design Code: X137
People / People



D092
Design Code: X128
Beyaz Mermer / White Marble



D092
Design Code: X129
Siyah Mermer / Black Marble

Örgü/Petek Dokulu Knit/Honeycomb Emboss



O005
Design Code: X21
Krem / Cream



O005
Design Code: X24
Beyaz / White



O005
Design Code: X23
Kahve / Brown



N009
Design Code: X21
Krem / Cream



N009
Design Code: X112
Rose / Rose



N009
Design Code: X38
Gri / Grey



N009
Design Code: X24
Beyaz / White



N009
Design Code: X88
Violet / Violet

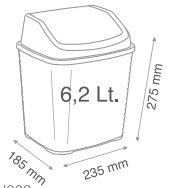
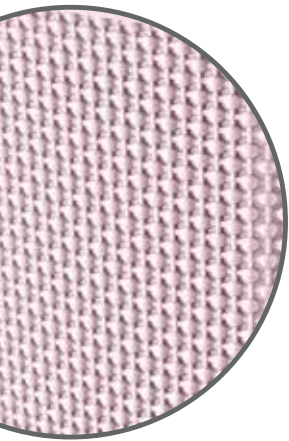

O005 - N009

PETEK & ÖRGÜ KLİK ÇÖP KOVALARI VE ELBİSE ASKISI HONEYCOMB & KNIT CLICK BINS AND CLOTHES HANGER

ÜRÜN KOD PRODUCT CODE	ÜRÜN ADI / AÇIKLAMA PRODUCT NAME	KAPASİTE CAPACITY LT.	TEK ÜRÜN AĞIRLIĞI PRODUCT WEIGHT	KOLİ İÇADET PCS IN BOX	KOLİ NET NET WEIGHT	KOLİ BRÜT GROSS WL.	KOLİ BOYUTU BOX DIMENSIONS (MM)	KOLİ M ³ BOX M ³	PAKETLEME SEKİLİ PACKING TYPE	BARKOD EAN 13 CODE
O005	Örgü Klük Çöp Kovası / Knit Click Bin	6,2 Lt.	0,391	24	9,38	9,92	465x390x595	0,108	BOX	869742230 247 2
N009	Petek Klük Çöp Kovası / Honeycomb Click Bin	6,2 Lt.	0,377	24	9,05	9,59	465x390x595	0,108	BOX	869742230 333 2
A005	Elbise Askısı 6'lı / Clothes Hanger 6 Pcs.		0,04	192	8	8,46	490x405x405	0,08	SLEEVE CARD + BOX	869742230 248 9

Klik Çöp Kovaları ve Askılıklar Click Bins and Clothes Hangers



A005
Design Code: X65
Açık Pembe / Light Pink

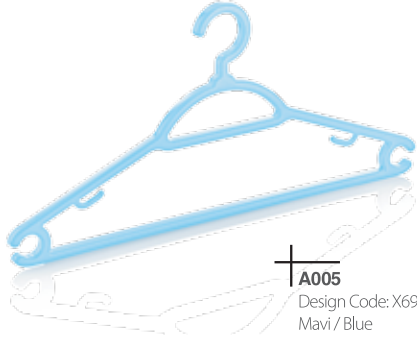

A005
Design Code: X69
Mavi / Blue

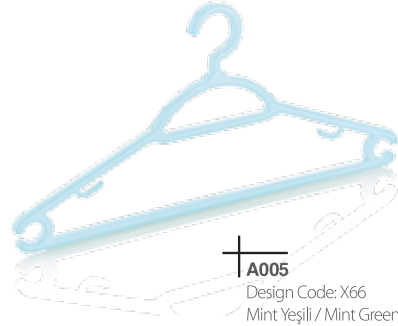

A005
Design Code: X66
Mint Yeşili / Mint Green



A005
Design Code: X21
Krem / Cream



A005
Design Code: X24
Beyaz / White



A005
Design Code: X23
Kahve / Brown

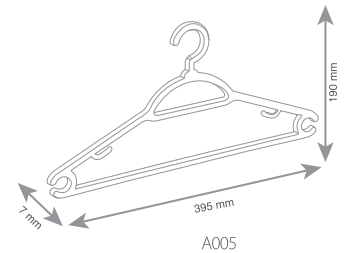

Petek Dokulu ve Desenli³⁹ Honeycomb Emboss



K013
Design Code: X24
Beyaz / White



K013
Design Code: X112
Rose / Rose



K013
Design Code: X23
Kahve / Brown



K013
Design Code: X21
Krem / Cream

EKONOMİK SERİ / ECO SERIES



K037
Design Code: X24
Beyaz / White



K037
Design Code: X112
Rose / Rose



K037
Design Code: X23
Kahve / Brown



K037
Design Code: X21
Krem / Cream



K013
K037
K012
K019

PACK TYPE

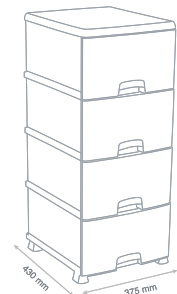

K013

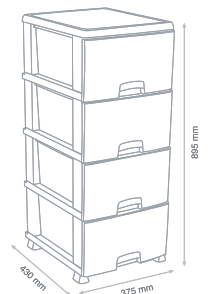

K012-K037

Komodınlar And Go Go Commode

NEW



K012
Design Code: X128
Beyaz Mermer / White Marble



K012
Design Code: X129
Siyah Mermer / Black Marble



K012
Design Code: X154
Yaprak / Leaf



K019
Design Code: X23
Kahve / Cream Brown



K012
Design Code: X04
Taş / Stone



K012
Design Code: X118
Wintage Lavanta / Wintage Lavender



K012
Design Code: X75
Parke / Parquet

PETEK DOKULU VE DESENLİ KOMODİN

HONEYCOMB EMBOSS AND GO GO COMMODE

ÜRÜN KODU PRODUCT CODE	ÜRÜN ADI / AÇIKLAMA PRODUCT NAME	KAPASİTE CAPACITY LT.	TEK ÜRÜN AĞIRLIĞI PRODUCT WEIGHT	KOLİ ÇADET PCS IN BOX	KOLİ NET NET WEIGHT	KOLİ BRÜT GROSS W.	KOLİ BOYUTU BOX DIMENSIONS (MM)	KOLİ M ³ BOX M ³	PAKETLEME ŞEKLİ PACKING TYPE	BARKOD EAN 13 CODE
K012	Desenli Komodin / Go Go Commode		4,87	1	4,87	5,03	39,5x42x41	0,069	SHRINK	869742230 347 9
K013	Petek Komodin / Honeycomb Commode		4,84	1	4,84	5	39,5x42x41	0,069	SHRINK	869742230 348 6
K037	Eko Petek Komodin / Eco Honeycomb Commode		4,44	1	4,44	4,6	39,5x42x41	0,069	SHRINK	869742230 351 6
K019	Ağaç Görünümlü / Wooden Emboss Commode		4,87	1	4,87	5,03	39,5x42x41	0,069	SHRINK	869742230 751 4

Katlı Basamaklar

Double Step Stools



B001
Design Code: X24
Beyaz / White



B001
Design Code: X21
Krem / Cream

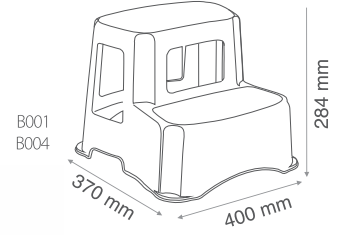

B004
Design Code: X85
Orkide / Orchid



B004
Design Code: X83
Paris / Paris



B004
Design Code: X84
Baykuş / Owl



B001
Design Code: X65
Pembe / Pink



B001
Design Code: X69
Mavi / Blue



B001
Design Code: X66
Yeşil / Green

KATLI BASAMAKLAR

DOUBLE STEP STOOLS

ÜRÜN KODU PRODUCT CODE	ÜRÜN ADI / AÇIKLAMA PRODUCT NAME	KAPASİTE CAPACITY LT.	TEK ÜRÜN AĞIRLIĞI PRODUCT WEIGHT	KOLİ ÇADET PCS IN BOX	KOLİ NET NET WEIGHT	KOLİ BRÜT GROSS W.	KOLİ BOYUTU BOX DIMENSIONS (MM)	KOLİ M ³ BOX M ³	PAKETLEME ŞEKLİ PACKING TYPE	BARKOD EAN 13 CODE
B001	Katlı Basamak / Double Step Stool		0,960	12	11,52	11,60	400x370x740	0,11	BULK	869742230 251 9
B004	Desenli Katlı Basamak / Go Go Double Step Stool		1040	12	12,48	12,48	400x370x740	0,11	BULK	869742230 255 7

Maxi Orta Boy Tabureler

Maxi Middle Size Stools



T010

Design Code: X24
Beyaz / White



T010

Design Code: X38
Gri / Gray



T010

Design Code: X21
Krem / Cream



T010

Design Code: X69
Mavi / Blue



T010

Design Code: X87
Pembe / Cherry



T011

Design Code: XT004



T011

Design Code: XT002



T011

Design Code: XT003



T011

Design Code: XT006



T011

Design Code: XT005



T011

Design Code: XT006

NEW

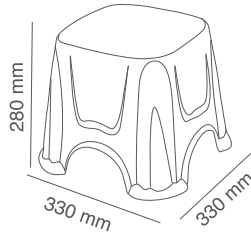

kaymaz ayaklar
non slip rubber feet



TABURELER STOOLS

ÜRÜN KODU PRODUCT CODE	ÜRÜN ADI / AÇIKLAMA PRODUCT NAME	KAPASİTE CAPACITY LT.	TEK ÜRÜN AĞIRLIĞI PRODUCT WEIGHT	KOLİ ADETİ PCS IN BOX	KOLİ NET AĞIRLIĞI NET WEIGHT	KOLİ BRÜT AĞIRLIĞI GROSS WL.	KOLİ BOYUTU BOX DIMENSIONS (MM)	KOLİ M ³ BOX M ³	PAKETLEME ŞEKLİ PACKING TYPE	BARKOD EAN 13 CODE
T010	Maxi Orta Boy Tabure / Maxi Middle Size Stool		0,587	25	14,68	14,68	330x330x1240	0,135	POLY BAG	869742230 746 0
T011	Desenli Maxi Orta Boy Tabure / Go Go Maxi Middle Size Stool		0,587	25	14,68	14,68	330x330x1240	0,135	POLY BAG	869742230 747 7

Hasır Dokulu Rattan

43



T001
Design Code: X38
Gri / Grey

T001
Design Code: X21
Krem / Cream

T001
Design Code: X23
Kahve / Brown



T002
Design Code: X38
Gri / Grey

T002
Design Code: X21
Krem / Cream

T002
Design Code: X23
Kahve / Brown

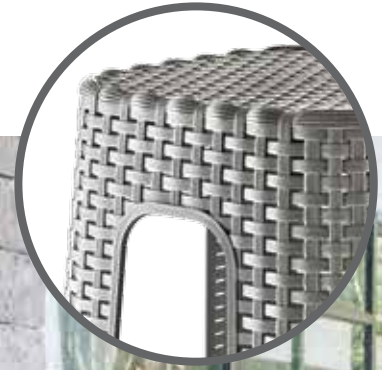

TABURELER VE KATLANIR SEHPA

RATTAN STOOLS AND FOLDABLE SIDE TABLE

ÜRÜN KODU PRODUCT CODE	ÜRÜN ADI / AÇIKLAMA PRODUCT NAME	KAPASİTE CAPACITY LT.	TEK ÜRÜN AĞIRLIĞI PRODUCT WEIGHT	KOLUÇADET PCS IN BOX	KOLU NET AĞIRLIĞI NET WEIGHT	KOLU BRÜT AĞIRLIĞI GROSS W.	KOLU BOYUTU BOX DIMENSIONS (MM)	KOLU M ³ BOX M ³	PAKETLEME ŞEKLİ PACKING TYPE	BARKOD EAN 13 CODE
T002	Orta Boy Hasır Tabure / Middle Size Rattan Stool		0,7	20	14,4	14,4	325x325x142	0,150	BULK	869742230 172 7
T001	Büyük Hasır Tabure / Big Rattan Stool		1	12	12	12	355x355x106	0,134	BULK	869742230 173 4
MS001	Katlanır Sehpa / Foldable Side Table		1,574	10	15,74	18,5	765x455x590	0,2	SLEEVE CARD + BOX	869742230 337 0
MS003	Desenli Katlanır Sehpa / Go Go Foldable Side Table		1,552	10	15,52	16,78	680x455x590	0,18	BOX	869742230 340 0

Tabureler ve Katlanır Sehpa

Stools and Foldable Side Table



MS001

Design Code: X24
Beyaz / White



MS001

Design Code: X113
Tik / Teak



MS001

Design Code: X21
Krem / Cream



MS003

Design Code: X123
Laleler / Tulips



MS003

Design Code: X129
Siyah Mermer / Black Marble



MS003

Design Code: X122
Deniz Feneri /
Lighthouse



MS003

Design Code: X128
Beyaz Mermer / White Marble

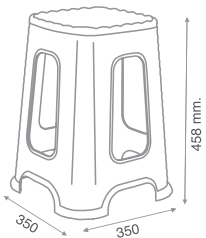
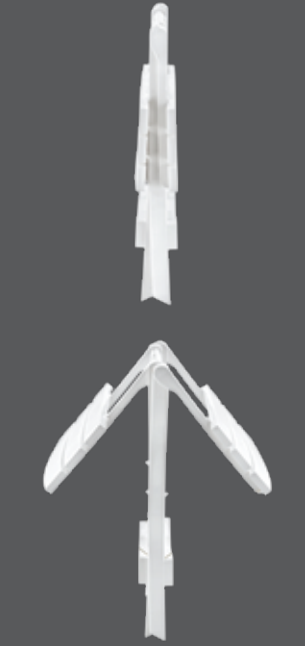

T001

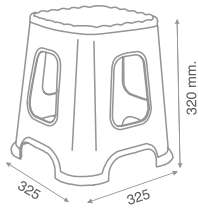

T002

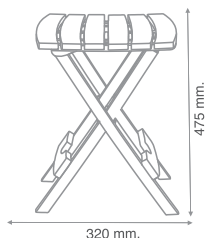

MS001

Desenli Ayakkabılık Go Go Shoes Rack

NEW



A003
Design Code:X157
Laminant / Laminate



A003
Design Code:X55
Kaz Ayağı / Pepita



A003
Design Code:X48
Deri / Leather



A003
Design Code:X129
Siyah Mermer / Black Marble



A003
Design Code:X120
Ahşap / Wooden



Kurulum videosu / Setup video

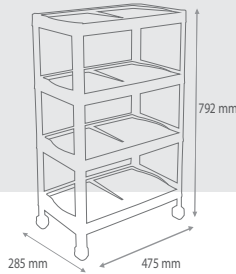

DESENLİ ÇOK AMAÇLI DAR RAF GO GO MULTIUSE SLIM RACK

ÜRÜN KODU PRODUCT CODE	ÜRÜN ADI / AÇIKLAMA PRODUCT NAME	KAPASİTE CAPACITY LT.	TEK ÜRÜN AĞIRLIĞI PRODUCT WEIGHT	KOLUÇ ADET PCS IN BOX	KOLU NET NET WEIGHT	KOLU BRÜT GROSS W.	KOLU BOYUTU BOX DIMENSIONS (MM)	KOLU M ³ BOX M ³	PAKETLEME ŞEKLİ PACKING TYPE	BARKOD EAN 13 CODE
A003	Desenli Ayakkabılık / Go Go Shoes Rack	1,63	1,63	6	9,82	10,81	585x485x468	0,13	BOX	8697 42230 759 0
D098	Desenli Çok Amaçlı Dar Tekerlekli Raf / Go Go Multiuse Slim Rack With Wheels	1,32	1,32	6	7,95	8,59	490x405x530	0,105	BOX	8697 42230 756 9

Çok amaçlı Desenli Dar Tekerlekli Raf

Go Go Multiuse Slim Rack With Wheels



Kilerde / at cellarroom



Banyoda / at bathroom



Mutfak / at kitchen



D098
Design Code:X143
Check / Check



D098
Design Code:X128
Beyaz Mermer / White Marble



D098
Design Code:X142
Vegan / Vegan



D098
Design Code:X141
Happy Time / Happy Time



A098
Design Code:X129
Siyah Mermer / Black Marble

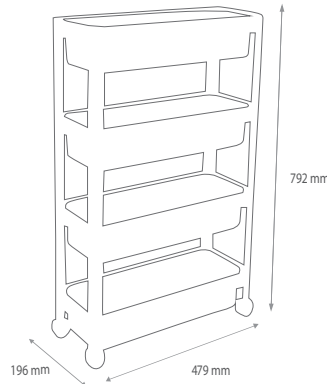

NEW

Kurulum videosu / Setup video





Kurulum videosu / Setup video



DESENLİ ÇOK AMAÇLI DİKDÖRTGEN TEKERLEKLİ RAF / GO GO MULTIUSE RECTANGULAR RACK WITH WHEELS

ÜRÜN KODU PRODUCT CODE	ÜRÜN ADI / AÇIKLAMA PRODUCT NAME	KAPASİTE CAPACITY LT.	TEK ÜRÜN AĞIRLIĞI PRODUCT WEIGHT	KOLUÇ ADET PCS IN BOX	KOLU NET AĞIRLIĞI NET WEIGHT	KOLU BRÜT AĞIRLIĞI GROSS W.	KOLU BOYUTU BOX DIMENSIONS (MM)	KOLU M ³ BOX M ³	PAKETLEME ŞEKLİ PACKING TYPE	BARKOD EAN 13 CODE
S097	Desenli Çok Amaçlı Dikdörtgen Tekerlekli Raf / Go Go Multiuse Rectangular Rack With Wheels		1,282	6	7,69	8,69	290x395x520	0,12	BOX	8697 42230 761 3

Çok Amaçlı Dikdörtgen Tekerlekli Raf

Multiuse Rectangular Rack With Wheels

NEW



S097

Design Code:X55
Kaz Ayağı / Pepita



S097

Design Code:X129
Siyah Mermer / Black Marble



S097

Design Code:X142
Vegan / Vegan



S097

Design Code:X141
Happy Time / Happy Time



S097

Design Code:X157
Laminant / Laminate



S097

Design Code:X128
Beyaz Mermer / White Marble



Dantel/Hasır/Petek/ Lacy/Rattan/

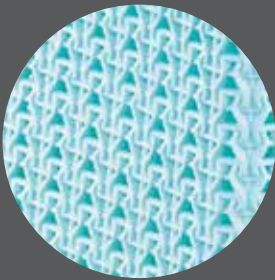

D071
Design Code: X23
Kahve / Brown



D071
Design Code: X24
Beyaz / White



D071
Design Code: X21
Krem / Cream



F003
Design Code: X23
Kahve / Brown



F003
Design Code: X24
Beyaz / White



F003
Design Code: X21
Krem / Cream

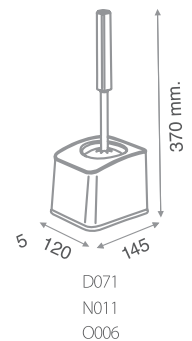
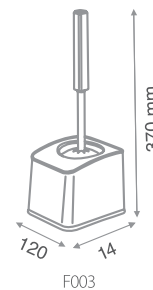

Örgü Dokulu WC Fırçaları Honeycomb/Knit WC Brushes



N011
Design Code: X21
Krem / Cream



Design Code: X88
Violet / Violet



N011
Design Code: X38
Gri / Grey



N011
Design Code: X112
Rose / Rose



N011
Design Code: X24
Beyaz / White

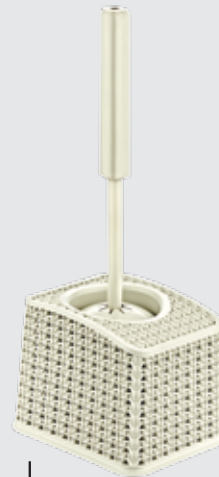

O006
Design Code: X21
Krem / Cream



O006
Design Code: X23
Kahve / Brown



O006
Design Code: X24
Beyaz / White

DOKULU WC FIRÇALARI

EMBOSS WC BRUSHES

ÜRÜN KODU PRODUCT CODE	ÜRÜN ADI / AÇIKLAMA PRODUCT NAME	KAPASİTE CAPACITY LT.	TEK ÜRÜN AĞIRLIĞI PRODUCT WEIGHT	KOLI ADET PCS IN BOX	KOLİ NET AĞIRLIĞI NET WEIGHT	KOLİ BRÜT AĞIRLIĞI GROSS W.	KOLİ BOYUTU BOX DIMENSIONS (MM)	KOLİ M ³ BOX M ³	PAKETLEME ŞEKLİ PACKING TYPE	BARKOD EAN 13 CODE
F003	Hasır Köşeli WC Fırçası / Rattan Rectangle WC Brush		0,181	24	4,344	4,94	610x390x415	0,1	BOX	869742230 159 8
D071	Dantelli Köşeli WC Fırçası / Lacy Rectangle Toilet Brush		0,179	24	4,296	4,93	610x390x415	0,1	BOX	869742230 198 7
N011	Petek Köşeli WC Fırçası / Honeycomb Rectangle WC Brush		0,188	24	4,51	5,12	610x390x415	0,1	BOX	869742230 335 6
O006	Örgü Köşeli WC Fırçası / Knit Rectangle WC Brush		0,185	24	4,44	5,05	610x390x415	0,1	BOX	869742230 249 6

Desenli/Metalize Go Go/Metallic



D026
Design Code: X75
Parke / Parquet



D026
Design Code: X129
Siyah Mermer /
Black Marble



D026
Design Code: X128
Beyaz Mermer /
White Marble



D026
Design Code: X04
Taş / Stone



D027
Design Code: X13
Sade Metalize / Plain Metallic



D027
Design Code: X111
Karbon Metalize /
Carbon Metallic

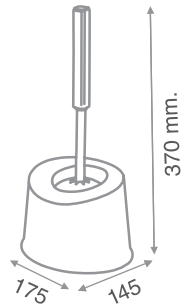

D026
D027

DESENLİ VE METALİZE WC FIRÇALARI

GO GO AND METALLIC WC BRUSHES

ÜRÜN KOD PRODUCT CODE	ÜRÜN ADI / AÇIKLAMA PRODUCT NAME	KAPASİTE CAPACITY LT.	TEK ÜRÜN AĞIRLIĞI PRODUCT WEIGHT	KOLU İÇ ADET PCS. IN BOX	KOLU NET AĞIRLIĞI NET WEIGHT	KOLU BRÜT AĞIRLIĞI GROSS WL.	KOLU BOYUTU BOX DIMENSIONS (MM)	KOLU M ³ BOX M ³	PAKETLEME ŞEKLİ PACKING TYPE	BARKOD EAN 13 CODE
D026	Desenli Oval WC Fırçası / Go Go Oval WC Brush		0,183	24	4,392	5,06	607x387x510	0,120	BOX	869742230 130 7
D027	Metalize Oval WC Fırçası / Metallic Oval WC Brush		0,185	24	4,44	5,1	607x387x510	0,120	BOX	869742230 134 5
D022	Desenli Köşeli WC Fırçası / Go Go Rectangle WC Brush		0,185	24	4,44	5,05	610x390x415	0,1	BOX	869742230 117 8
D023	Metalize Köşeli WC Fırçası / Metallic Rectangle WC Brush		0,192	24	4,608	5,22	610x390x415	0,1	BOX	869742230 119 2

Oval ve Köşeli WC Fırçaları

Oval and Rectangle WC Brushes



D022
Design Code: X75
Parke / Parquet



D022
Desing Code: X137
People / People



D022
Design Code: X118
Vintage Lavanta / Vintge Lavander



D022
Design Code: X04
Taş / Stone



D022
Design Code: X129
Siyah Mermer / Black Marble



D022
Desing Code: X138
Morning / Morning



D022
Design Code: X128
Beyaz Mermer / White Marble



D023
Design Code: X13
Sade Metalize / Plain Metallic



D023
Design Code: X111
Karbon Metalize / Carbon Metallic

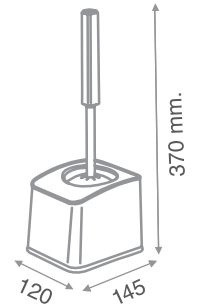

D022
D023

Desenli / Metalize Go Go / Metallic

NEW



D018

Desing Code:X137
People / People



D018

Design Code: X75
Parke / Parquet

NEW



D018

Desing Code:X138
Morning / Morning



D018

Design Code: X118
Vintage Lavanta /
Vintage Lavander



D018

Design Code: X129
Siyah Mermer /
Black Marble



D018

Design Code: X128
Beyaz Mermer /
White Marble



D020

Design Code: X13
Sade Metalize /
Plain Metallic



D020

Design Code: X111
Karbon Metalize /
Carbon Metallic



D018

Design Code: X04
Taş / Stone

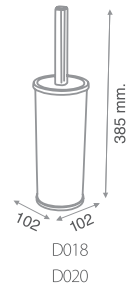

D018
D020



YUVARLAK WC FIRÇALARI / MAŞRAPALAR ROUND WC BRUSHES / PITCHERS

ÜRÜN KOD PRODUCT CODE	ÜRÜN ADI / AÇIKLAMA PRODUCT NAME	KAPASİTE CAPACITY LT.	TEK ÜRÜN AĞIRLIĞI PRODUCT WEIGHT	KOLUÇ ADET PCS IN BOX	KOLU NET NET WEIGHT	KOLU BRÜT GROSS WL	KOLU BOYUTU BOX DIMENSIONS (MM)	KOLU M ³ BOX M ³	PAKETLEME ŞEKLİ PACKING TYPE	BARKOD EAN 13 CODE
D018	Desenli Yuvarlak WC Fırçası / Go Go Round WC Brush		0,203	24	4,872	5,53	630x425x390	0,104	BOX	869742230 106 2
D020	Metalize Yuvarlak WC Fırçası / Metallic Round WC Brush		0,203	24	4,872	5,53	630x425x390	0,104	BOX	869742230 107 9
M007	Desenli Maşrapa / Go Go Pitcher For Toilet	1,4Lt.	0,081	72	5,832	5,832	415x280x580	0,067	POLY BAG	869742230 113 0
D025	Metalize Maşrapa / Metallic Pitcher For Toilet	1,4Lt.	0,082	72	5,904	5,904	415x280x580	0,067	POLY BAG	869742230 135 2

Yuvarlak WC Fırçaları ve Maşrapalar Round WC Brushes and Pitchers



M007
Design Code: X128
Beyaz Mermer / White Marble



M007
Design Code: X129
Siyah Mermer / Black Marble



M007
Design Code: X04
Taş / Stone



M007
Design Code: X75
Parke / Parquet



D025
Design Code: X111
Karbon Metalize / Carbon Metallic



M007
D025

Desenli Go Go



D012
Desing Code: X137
People / People



D012
Design Code: X75
Parke / Parquet



D012
Design Code: X118
Vintage Lavanta /
Vintage Lavander



D012
Design Code: X138
Morning / Morning



D012
Design Code: X129
Siyah Mermer / Black Marble



D012
Design Code: X128
Beyaz Mermer / White Marble



D012
Design Code: X04
Taş / Stone

TEMİZLİK VE SU KOVALARI

CLEANING AND WATER BUCKETS

ÜRÜN KODU PRODUCT CODE	ÜRÜN ADI / AÇIKLAMA PRODUCT NAME	KAPASİTE CAPACITY LT.	TEK ÜRÜN AĞIRLIĞI PRODUCT WEIGHT	KOLUÇ ADET PCS IN BOX	KOLU NET NET WEIGHT	KOLU BRÜT GROSS W.	KOLU BOYUTU BOX DIMENSIONS (MM)	KOLU M ³ BOX M ³	PAKETLEME ŞEKLİ PACKING TYPE	BARKOD EAN 13 CODE
D012	Desenli Temizlik Kovası & Sıkma / Go Go Cleaning Bucket & Wringer	14 Lt.	0,609	24	14,616	15,74	580x400x545	0,126	BOX	869742230 087 4
K002	5 No Desenli Su Kovası & Kapak / 5 No Go Go Water Bucket & Cover	21 Lt.	0,685	50	34,25	34,25	0,71	0,372	BULK	869742230 089 8
K001	4 No Desenli Su Kovası & Kapak / 4 No Go Go Water Bucket & Cover	16 Lt.	0,623	50	31,15	31,15	0,68	0,287	BULK	869742230 091 1
K024	Safir Su Kovası No:4 & Kapak / Sapphire Water Bucket No:4 Cover	16 Lt.	0,623	50	31,15	31,15	0,68	0,287	BULK	869742230 355 4
K027	Safir Su Kovası No:5 & Kapak / Sapphire Water Bucket No:5 & Cover	21 Lt.	0,725	50	36,25	36,25	0,71	0,372	BULK	869742230 341 7

Temizlik ve Su Kovaları

Cleaning and Water Buckets



K001
Design Code: X15
Okyanus / Ocean



K001
Design Code: X16
Prenseler / Princess



K001
Design Code: X118
Vintage Lavanta / Vintage Lavender



K001
Design Code: X83
Paris / Paris



K001
Design Code: X04
Taş / Stone

16
LT

K001
Design Code: X41
Arabalar / Cars



K001
Design Code: X40
Peri / Fairy



K001
Design Code: X14
Hayvanlı / Animals



K001
Design Code: X80
Marin / Marine

16
LT

K027
Design Code: X1015
Şeffaf Siyah / Clear Black

21
LT

K024
Design Code: X1015
Şeffaf Siyah / Clear Black

16
LT

K027
Design Code: X89
Safir / Sapphire

21
LT

K024
Design Code: X89
Safir / Sapphire

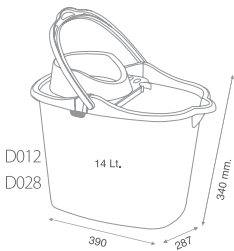
16
LT

K001 - K024

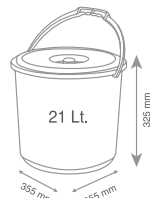

K002 K027

04

mutfak
ürünleri
kitchen
products

tidy and healthy
kılgın ve sağlıklı



Smart Bulaşıkliklar

Smart Dish Drainers

NEW



T020

Design Code: X129
Siyah Mermer / Black Marble



T019

Design Code: X129
Siyah Mermer / Black Marble



T019

Design Code: X129
Siyah Mermer / Black Marble



T020

Design Code: X129
Siyah Mermer / Black Marble

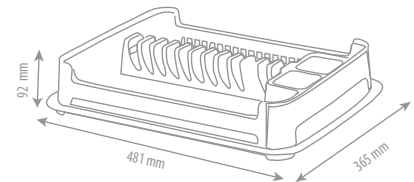

SMART BULAŞIKLIKLAR SMART DISH DRAINERS

ÜRÜN KODU PRODUCT CODE	ÜRÜN ADI / AÇIKLAMA PRODUCT NAME	KAPASİTE CAPACITY LT.	TEK ÜRÜN AĞIRLIĞI PRODUCT WEIGHT	KOLİ ÇADET PCS IN BOX	KOLİ NET AĞIRLIĞI NET WEIGHT	KOLİ BRÜT AĞIRLIĞI GROSS W.	KOLİ BOYUTU BOX DIMENSIONS (MM)	KOLİ M ³ BOX M ³	PAKETLEME ŞEKLİ PACKING TYPE	BARKOD EAN 13 CODE
T019	Smart Desenli Bulaşıklik / Smart Deco Dish Drainer		0,576 kg	24	13,84 kg	15,07 kg	710x505x560	0,2	BOX	869742230 800 9
T020	Smart Metalize Bulaşıklik / Smart Metallic Dish Drainer		0,576 kg	24	13,84 kg	15,07 kg	710x505x560	0,2	BOX	869742230 801 6

Katlı Bulaşıklık / Köşeli Double Layer Dish Drainer / Rectangle



T005
Design Code: X38
Gri / Gray



T005
Design Code: X24
Beyaz / White



T005
Design Code: X23
Kahve / Brown



T005
Design Code: X73
Kırmızı / Red

TRANSPARENT

NEW



T006
Design Code: X101
Şeffaf / Clear



T006
Design Code: X101S
Şeffaf Siyah / Clear Black

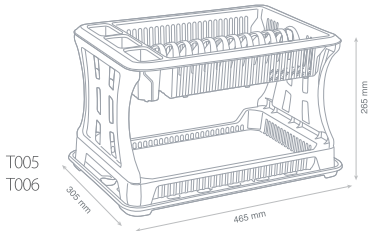

PETEK DOKULU KATLI BULAŞIKLIK HONEYCOMB EMBOSS DOUBLE LAYER DISH DRAINER

ÜRÜN KODU PRODUCT CODE	ÜRÜN ADI / AÇIKLAMA PRODUCT NAME	KAPASİTE CAPACITY LT.	TEK ÜRÜN AĞIRLIĞI PRODUCT WEIGHT	KOLİ KAÇADET PCS IN BOX	KOLİ NET NET WEIGHT	KOLİ BRÜT GROSS WL.	KOLİ BOYUTU BOX DIMENSIONS (MM)	KOLİ M ³ BOX M ³	PAKETLEME ŞEKLİ PACKING TYPE	BARKOD EAN 13 CODE
T005	Petek Katlı Bulaşıklık / Honeycomb Double Layer Dish Drainer		0,846	12	10,152	10,932	605x460x590	0,16	BOX	869742230 352 3
T006	Petek Katlı Bulaşıklık Şeffaf / Honeycomb Double Layer Dish Drainer Transparent		0,846	12	10,152	10,932	605x460x590	0,16	BOX	869742230 739 2

Kilitli / Fresh Saklama Kabı Seti Locked / Fresh Storage Box Set

X130 /Dinosaurs X133 /Flora X134 /Belinda



X131 / Pony X132 / Good Morning

0,3
LT

0,45
LT

0,65
LT

1
LT



F012
Fresh Saklama Kabı Seti
Fresh Storage Box Set
X133 Flora

4 in 1

NEW



PACK TYPE

1,7 Lt
2,7 Lt
4,6 Lt
8,2 Lt



S019
Design Code: X89
4 Pcs Set



S013
Design Code: X89
No 4



S012
Design Code: X89
No 3



S011
Design Code: X89
No 2



S010
Design Code: X89
No 1



S014
Design Code: X89
No 5

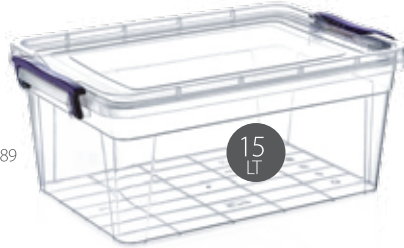

S015
Design Code: X89
No 6

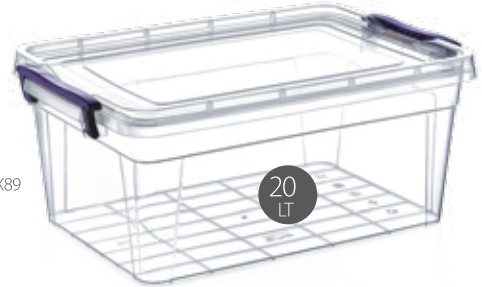

S019
Desing Code: X1015
4 Adet / 4 Pcs

NEW



S013
Desing Code: X1015
4 No Saklama /
Storage box No:4

NEW



S012
Desing Code: X1015
3 No Saklama /
Storage box No:3

NEW



S011
Desing Code: X1015
2 No Saklama /
Storage box No:2

NEW



S010
Desing Code: X1015
1 No Saklama /
Storage box No:1

NEW

KÖŞELİ KİLİTLİ VE FRESH SAKLAMA KAPLARI RECTANGLE LOCKED AND FRESH CONTAINERS

ÜRÜN KODU PRODUCT CODE	ÜRÜN ADI / AÇIKLAMA PRODUCT NAME	KAPASİTE CAPACITY LT.	TEK ÜRÜN AĞIRLIĞI PRODUCT WEIGHT	KOLU ÇADET PCS IN BOX	KOLU NET NET WEIGHT	KOLU BRÜT GROSS W.	KOLU BOYUTU BOX DIMENSIONS (MM)	KOLU M ³ BOX M ³	PAKETLEME ŞEKLİ PACKING TYPE	BARKOD EAN 13 CODE
S010	1 No Köşeli Kilitli Saklama Kabı / Rectangle Locked Container No. 1	1,7 Lt.	0,111	48	5,328	5,76	475x290x450	0,062	BOX	869742230 154 3
S011	2 No Köşeli Kilitli Saklama Kabı / Rectangle Locked Container No. 2	2,7 Lt.	0,185	48	8,88	9,61	565x340x463	0,089	BOX	869742230 155 0
S012	3 No Köşeli Kilitli Saklama Kabı / Rectangle Locked Container No. 3	4,6 Lt.	0,288	24	6,912	7,41	415x340x510	0,072	BOX	869742230 156 7
S013	4 No Köşeli Kilitli Saklama Kabı / Rectangle Locked Container No. 4	8,2 Lt.	0,384	24	9,216	9,84	490x390x540	0,103	BOX	869742230 157 4
S014	5 No Köşeli Kilitli Saklama Kabı / Rectangle Locked Container No. 5	15 Lt.	0,538	12	6,456	7,04	435x290x640	0,081	BOX	869742230 163 5
S015	6 No Köşeli Kilitli Saklama Kabı / Rectangle Locked Container No. 6	20 Lt.	0,76	12	9,12	9,77	495x330x675	0,110	BOX	869742230 164 2
S019	Köşeli Kilitli Saklama 4'lü Set / Rectangle Locked Container 4 Pcs. Set	1,7+2,7+4,6+8,2 Lt.	0,968	12 SET	11,616	12,23	485x370x860	0,154	SLEEVE CARD BOX	869742230 160 4
F012	Fresh Saklama Kabı Seti / Fresh Storage Box Sets	0,3 + 0,45 + 0,65 + 1 Lt.	0,192	24	4,61	5,03	425x285x270	0,032	COLOR BOX	869742230 738 5

Limonluklar Lemon Squeezers



L024
Design Code: X67
Sar / Yellow



L024
Design Code: X24
Beyaz / White



L023
Design Code: X136
Hayvanlar / Animals



L023
Design Code: X62
Limon / Lemon



L023
Design Code: X135
Yeşil Limon / Green Lemon

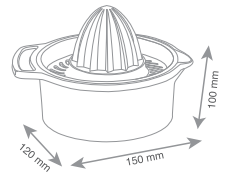

L023
L024

LİMONLUKLAR / ÇOK AMAÇLI SÜZGEÇ LEMON SQUEEZERS / MULTIPURPOSE COLANDER SET

ÜRÜN KOD PRODUCT CODE	ÜRÜN ADI / AÇIKLAMA PRODUCT NAME	KAPASİTE CAPACITY LT.	TEK ÜRÜN AĞIRLIĞI PRODUCT WEIGHT	KOLİ ÇADET PCS IN BOX	KOLİ NET NET WEIGHT	KOLİ BRÜT GROSS WL.	KOLİ BOYUTU BOX DIMENSIONS (MM)	KOLİ M ³ BOX M ³	PAKETLEME ŞEKLİ PACKING TYPE	BARKOD EAN 13 CODE
L023	Desenli Limon & Portakal Sıkacağı / Go Go Lemon & Orange Squeezer		0,059	48	2,83	4,21	517x415x420	0,09	SHRINK BOX	869742230 223 6
L024	Limon & Portakal Sıkacağı / Lemon & Orange Squeezer		0,059	48	2,83	4,09	395x310x500	0,061	SLEEVE CARD BOX	869742230 229 8
S099	Çok Amaçlı Süzgeç&Kase Seti / Multipurpose Colander&Bowl Set	3 Lt	0,333	24	8	8,8	620x530x315	0,1	SLEEVE CARD BOX	869742230 253 3

Çok Amaçlı Süzgeç Seti

Multipurpose Colander & Bowl Set



S099
Design Code: X73
Kırmızı / Red



S099
Design Code: X25
Mor / Purple



S099
Design Code: X72
Yeşil / Green

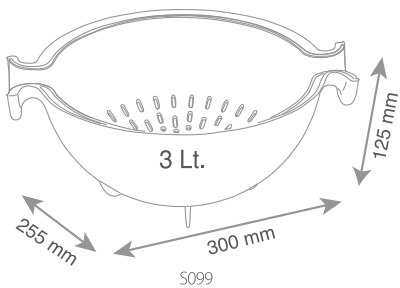

Bulaşıklıklar / Piknik Sepetleri / Dish Drainers / Picnic Basket



D060
Design Code: X13
Sade Metalize / Plain Metallic



D059
Design Code: X118
Wintage Lavanta / Wintage Lavander



N012
Design Code: X112
Rose / Rose



D059
Design Code: X140
Food / Food

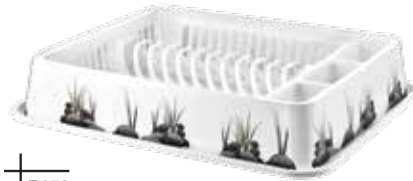

D059
Design Code: X04
Taş / Stone



N012
Design Code: X21
Krem / Cream



D059
Design Code: X139
Ice Cream / Ice Cream



D059
Design Code: X128
Beyaz Mermer / White Marble



N012
Design Code: X24
Beyaz / White

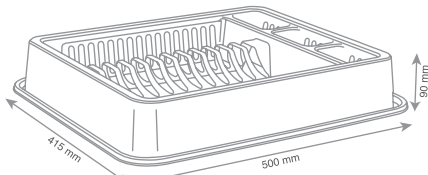

D060 T032 N012
D059 T042



D059
Design Code: X129
Siyah Mermer / Black Marble



N012
Design Code: X66
Mint Yeşili / Mint Green

BULAŞIKLIK / PİKNIK SEPETLERİ / ÇEKMECE TİPİ KAŞIKLIK

DISH DRAINERS / PICNIC BASKETS / WIDE SIZE CUTLERY

ÜRÜN KODU PRODUCT CODE	ÜRÜN ADI / AÇIKLAMA PRODUCT NAME	KAPASİTE CAPACITY LT.	TEK ÜRÜN AĞIRLIĞI PRODUCT WEIGHT	KOLUÇ ADET PCS IN BOX	KOLU NET NET WEIGHT	KOLU BRÜT GROSS W.	KOLU BOYUTU BOX DIMENSIONS (MM)	KOLU M ³ BOX M ³	PAKETLEME ŞEKLİ PACKING TYPE	BARKOD EAN 13 CODE
D059	Desenli Bulaşıklık / Go Go Dish Drainer		0,741	20	14,82	16	525x435x510	0,116	BOX	869742230 161 1
D060	Metalize Bulaşıklık / Metallic Dish Drainer		0,74	20	14,8	16	525x435x510	0,116	BOX	869742230 162 8
T042	Örgü Bulaşıklık / Knit Dish Drainer		0,77	20	15,4	16,58	520x425x700	0,154	BOX	869742230 230 4
T032	Dantelli Bulaşıklık / Lacy Dish Drainer		0,73	20	14,6	15,9	520x425x700	0,154	BOX	869742230 185 7
N012	Petek Bulaşıklık / Honeycomb Dish Drainer		0,757	20	15,14	16,44	520x425x700	0,154	BOX	869742230 336 3
D032	Desenli Piknik Sepeti / Go Go Picnic Basket	24,5 Lt.	0,909	12	10,908	11,76	670x480x395	0,127	BOX	869742230 122 2
C008	Çekmece Tipi Kaşıklık / Wide Size Cutlery		0,384	24	7,68	8,28	445x395x355	0,06	BOX	869742230 735 4
C009	Şeffaf Çekmece Tipi Kaşıklık / Wide Size Cutlery Clear		0,384	24	7,68	8,28	445x395x355	0,06	BOX	869742230 736 1

66 Çekmece Tipi Kaşıklıklar Wide Size Cütleri



T042
Design Code: X21
Krem / Cream



T042
Design Code: X24
Beyaz / White



T032
Design Code: X21
Krem / Cream



T032
Design Code: X24
Beyaz / White



C008
Design Code: X69
Mavi / Blue



C008
Design Code: X24
Beyaz / White



C008
Design Code: X38
Gri / Gray

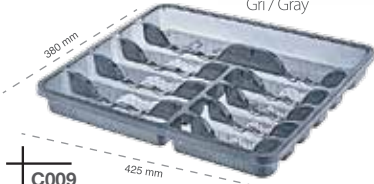

C009
Design Code: X1015
Şeffaf Siyah / Clear Black



C009
Design Code: X101
Şeffaf / Transparent



D032
Design Code: X75
Parke / Parquet

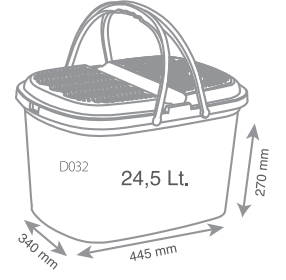

D032
Design Code: X128
Beyaz Mermer / White Marble



D032
Design Code: X04
Taş / Stone



D032
Design Code: X129
Siyah Mermer / Black Marble



Kaymaz Çift Renkli Kesim Panosu Logolu

Non-Slip Double-Color Chopping Board With Logo

67

NEW



K040

Design Code: X24-X73
Beyaz & Kırmızı / White & Red



K040

Design Code: X38-X67
Gri & Sarı / Gray & Yellow



K040

Design Code: X24-X38
Gri & Beyaz / White & Gray



KAYMAZ ÇİFT RENKLİ KESİM PANOSU LOGOLU NON-SLIP DOUBLE-COLOR CHOPPING BOARD WITH LOGO

ÜRÜN KODU PRODUCT CODE	ÜRÜN ADI / AÇIKLAMA PRODUCT NAME	KAPASİTE CAPACITY LT.	TEK ÜRÜN AĞIRLIĞI PRODUCT WEIGHT	KOLİ ÇADET PCS IN BOX	KOLİ NET NET WEIGHT	KOLİ BRÜT GROSS WL.	KOLİ BOYUTU BOX DIMENSIONS (MM)	KOLİ M ³ BOX M ³	PAKETLEME ŞEKLİ PACKING TYPE	BARKOD EAN 13 CODE
K040	Kaymaz Çift Renkli Kesim Panosu Logolu / Non-Slip Double-Color Chopping Board With Logo		0,553	25	13,84	14,14	353X263X210	0,017	BOX	8697422306706
K014	1 No Kesim Panosu / 1 No Chopping Board		0,251	25	6,275	6,39	275x180x185	0,009	BOX	869742230614
K015	2 No Kesim Panosu / 2 No Chopping Board		0,349	25	8,725	8,94	320x220x185	0,013	BOX	869742230621
K016	3 No Kesim Panosu / 3 No Chopping Board		0,541	25	12,85	13,1	365x275x185	0,019	BOX	869742230638
K017	4 No Kesim Panosu / 4 No Chopping Board		0,732	20	14,64	14,91	420x285x165	0,020	BOX	869742230720
K018	3 No Kaymaz Kesim Panosu / Non-Slip Chopping Board No:3		0,557	25	13,93	14,1	365x280x190	0,019	BOX	8697422302458

ve Kesim Panoları and Chopping Boards

**NON
SLIP**

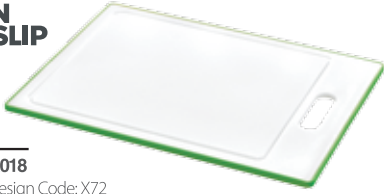

K018
Design Code: X72
Yeşil / Green

**NON
SLIP**



K018
Design Code: X73
Kırmızı / Red

**NON
SLIP**



K018
Design Code: X25
Mor / Purple



K014



K015



K016



K017

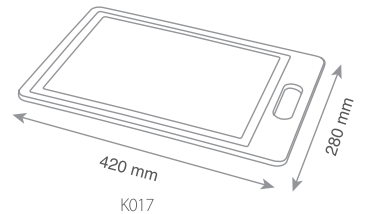
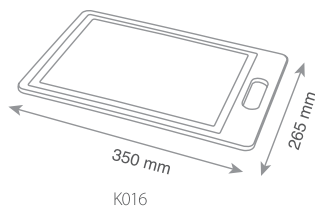
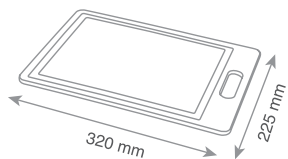
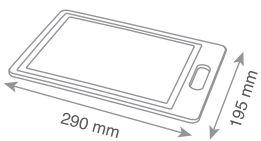
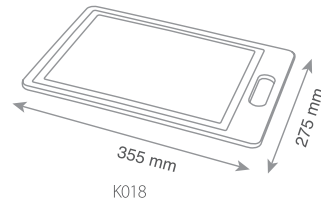
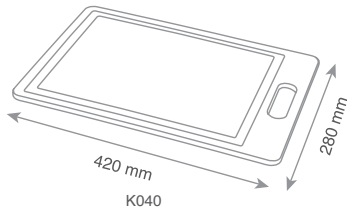

Süngerlikler Sponge Holders



D061
Design Code: X140
Food / Food



D061
Design Code: X129
Siyah Mermer / Black Marble



D061
Design Code: X128
Beyaz Mermer / White Marble



D061
Design Code: X04
Taş / Stone



D061
Design Code: X31
Lavanta / Lavander



D061
Design Code: X139
Ice Cream / Ice Cream

PACK TYPE



SÜNGERLİK / SÜRAHİ VE KESİM PANOLARI

SPONGE HOLDERS / PITCHERS AND CHOPPING BOARDS

ÜRÜN KODU PRODUCT CODE	ÜRÜN ADI / AÇIKLAMA PRODUCT NAME	KAPASİTE CAPACITY LT.	TEK ÜRÜN AĞIRLIĞI PRODUCT WEIGHT	KOLİ KADET PCS IN BOX	KOLİ NET NET WEIGHT	KOLİ BRÜT GROSS W.	KOLİ BOYUTU BOX DIMENSIONS (MM)	KOLİ M ³ BOX M ³	PAKETLEME ŞEKLİ PACKING TYPE	BARKOD EAN 13 CODE
D061	Desenli Süngerlik / Go Go Sponge Holder With Dispenser		0,129	24	3,096	3,7	650x300x250	0,049	SLEEVE CARD COLOR BOX	869742230 166 6
S036	Orient Sürahi / Orient Crystal Pitcher	2 Lt.	0,287	24	6,88	7,708	575x385x480	0,106	SHRINK+BOX	869742230 204 5
S007	Oval Ayrar Sürahis / Oval Chum	2 Lt.	0,183	24	3,66	4,32	607x387x510	0,120	SHRINK+BOX	869742230 026 3
S008	Desenli Sürahi / Go Go Pitcher	2 Lt.	0,183	40	7,32	8,32	750x500x465	0,174	SHRINK+BOX	869742230 086 7
S020	Random Sürahi / Random Pitcher	2 Lt.	0,24	24	6,88	7,708	575x385x480	0,106	BOX	869742230 214 4

Sürahiler

Jugs

2
LT

S007

Design Code: X129
Siyah Mermer / Black Marble

NEW



S007

Design Code: X138
Morning / Morning

S007

Design Code: X128
Beyaz Mermer / White Marble

NEW



S007

Design Code: X137
People / People

S007

Design Code: X04
Taş / Stone2
LT

S008

Design Code: X129
Siyah Mermer / Black Marble

NEW



S008

Design Code: X138
Morning / Morning

S008

Design Code: X128
Beyaz Mermer / White Marble

NEW



S008

Design Code: X137
People / People

S008

Design Code: X04
Taş / Stone

S036

Design Code: X89
Orient Sürahi / Orient Crystal Pitcher2
LT

S020

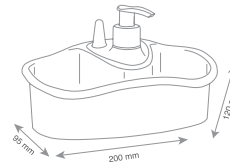
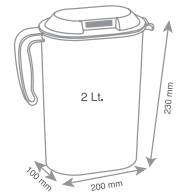
Design Code: X101
Random Orient Sürahi
Random Orient PitcherD061
D062S020
S036S007
S008

05

**bebek / çocuk
ürünleri**

baby/child
accessories



renk ve mutluluk
ssendiday puz sroloos
colors and happiness

5'li Bebek ⁷³ 5 Pcs Baby



C027
Design Code: X80
Marin / Marine

PACK TYPE



C027
Design Code: X14
Hayvanlı / Animals

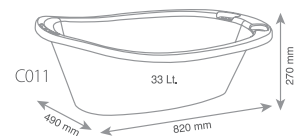
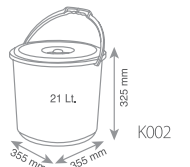
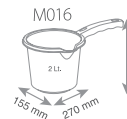
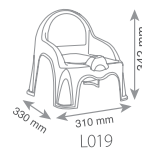

Banyo Seti Bath Set



C011

K002

M016

L019



C027

Design Code: X40
Peri / Fairy

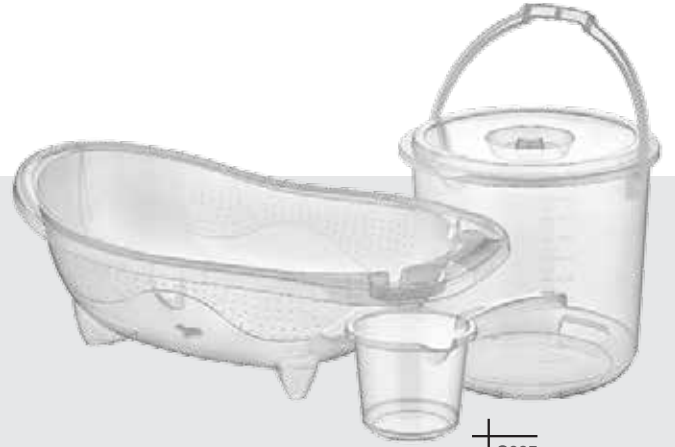

C005

Şeffaf / Transparent



C027

Design Code: X15
Okyanus / Ocean



C027

Design Code: X16
Prenses / Princess



C027

Design Code: X41
Arabalar / Cars



BEBEK BANYO SETİ

BABY BATH SET

ÜRÜN KODU PRODUCT CODE	ÜRÜN ADI / AÇIKLAMA PRODUCT NAME	KAPASİTE CAPACITY LT.	TEK ÜRÜN AĞIRLIĞI PRODUCT WEIGHT	KOLİ ÇADET PCS IN BOX	KOLİ NET NET WEIGHT	KOLİ BRÜT GROSS W.	KOLİ BOYUTU BOX DIMENSIONS (MM)	KOLİ M ³ BOX M ³	PAKETLEME ŞEKLİ PACKING TYPE	BARKOD EAN 13 CODE
C027	Bebek Banyo Seti (5 prç.) - Demonte / Baby Bath Set (5 pcs.) - Demonte		2,382	1 SET	2,382	2,382		0,032	BULK	869742230 153 6
C027	Bebek Banyo Seti (5 prç.) / Baby Bath Set (5 pcs.)		2,382	1 SET	2,382	3,43	820x490x360	0,145	COLOR BOX	869742230 153 6
C005	3'lü Safir Bebek Seti - Demonte / 3 Pcs Sapphire Baby Bath Set With Dariner - Demonte		1,830	1 SET	1,830	1,830		0,032	BULK	869742230 737 8



C011
Design Code: X80
Marin / Marine



C011
Design Code: X14
Hayvanlı / Animals



C011
Design Code: X41
Arabalar / Cars



C011
Design Code: X40
Peri / Fairy



C011
Design Code: X15
Okyanus / Ocean



C011
Design Code: X16
Prenses / Princess

KÜVETLER BATHTUB

ÜRÜN KODU PRODUCT CODE	ÜRÜN ADI / AÇIKLAMA PRODUCT NAME	KAPASİTE CAPACITY LT.	TEK ÜRÜN AĞIRLIĞI PRODUCT WEIGHT	KOLİ ADET PCS IN BOX	KOLİ NET NET WEIGHT	KOLİ BRÜT GROSS WL.	KOLİ BOYUTU BOX DIMENSIONS (MM)	KOLİ M ³ BOX M ³	PAKETLEME ŞEKLİ PACKING TYPE	BARKOD EAN 13 CODE
C011	Desenli Çocuk Küveti / Go Go Bathtub	33 Lt.	1,062	50	53,55	53,55	820x490x330	0,480	POLY BAG	869742230 129 1
C001	Safir Bebek Küveti & Sapphire Baby Bathtub - TİPALI	39 Lt.	1,069	50	53,45	53,45	800x490x940	0,368	POLY BAG	869742230 342 4
C002	Safir Renkli Bebek Küveti & Sapphire Colorful Baby Bathtub - TİPASIZ	39 Lt.	1,069	50	53,45	53,45	800x490x940	0,368	POLY BAG	869742230 343 1
C003	Safir Bebek Küveti Şeffaf & Sapphire Baby Bathtub Transparent - TİPASIZ	39 Lt.	1,069	50	53,45	53,45	800x490x940	0,368	POLY BAG	869742230 349 3
C004	Safir Renkli Bebek Küveti & Sapphire Colorful Baby Bathtub - TİPALI	39 Lt.	1,069	50	53,45	53,45	800x490x940	0,368	POLY BAG	869742230 350 9

Küvetleri Bathtubs

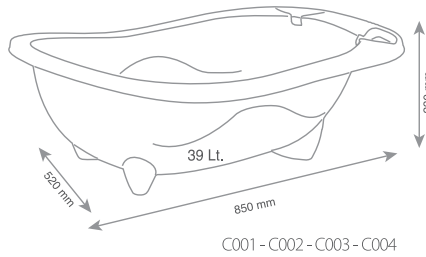
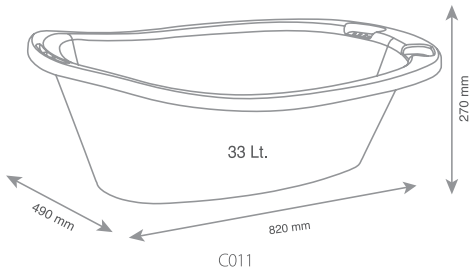

Tombik Mama Koltuğu⁷⁷

Tombik Feeding Seat

NEW



M099
Design Code:X145
Lunapark / Fun Fair



M099
Design Code:X147
Sualtı / Underwater



M099
Design Code:X144
Unicorn / Unicorn

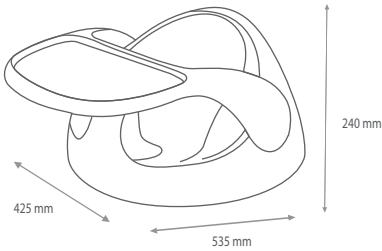

M099
Design Code:X146
Çiftlik / Farm



M099
Design Code:X147
Su Altı / Underwater



TOMBİK MAMA KOLTUĞU VE PATİ LAZIMLIK

TOMBİK FEEDING SEAT AND PATI POTTY

ÜRÜN KODU PRODUCT CODE	ÜRÜN ADI/AÇIKLAMA PRODUCT NAME	KAPASİTE CAPACITY LT.	TEK ÜRÜN AĞIRLIĞI PRODUCT WEIGHT	KOLİ ÇADET PCS IN BOX	KOLİ NET AĞIRLIK NET WEIGHT	KOLİ BRÜT AĞIRLIK GROSS W.	KOLİ BOYUTU BOX DIMENSIONS (MM)	KOLİ M ³ BOX M ³	PAKETLEME ŞEKLİ PACKING TYPE	BARKOD EAN 13 CODE
M099	Tombik Mama Koltuğu / Tombik Feeding Seat		1,100	1	1,100	1,480	430X250X430	0,046	BOX	8697 42230 757 6
M099	Tombik Mama Koltuğu Demonte / Tombik Feeding Seat Demonte		1,100	6	6,60	6,98	470X430X700	0,14	BOX	8697 42230 757 6
L027	Patı Lazımlık / Pati Potty		0,448	12	5,378	5,818	305X350X602	0,062	BOX	8697 42230 758 3

Pati Lazımlık

Pati Potty

NEW



L027
Design Code:X150
Fil / Elephant



L027
Design Code:X149
Tilki / Fox



L027
Design Code:X151
Penguen / Penguin

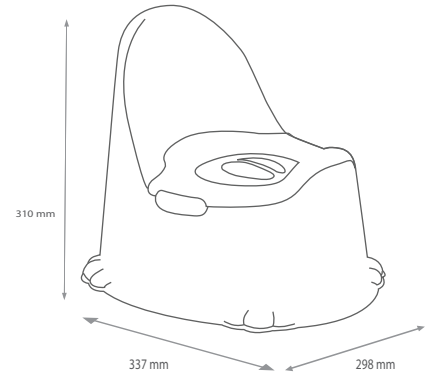

L027
Design Code:X148
İnek / Cow



L027
Design Code:X152
Panda / Panda

Çocuk Oyuncak Kutusu Child Toys Box



SB006
Design Code: X40
Peri / Fairy



SB006
Design Code: X41
Arabalar / Cars



SB006
Design Code: X80
Marin / Marin



A007
Design Code: X15
Okyanus / Ocean



A007
Design Code: X41
Arabalar / Cars



A007
Design Code: X16
Prenses / Princess

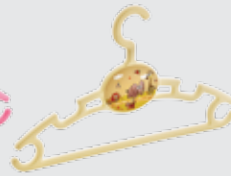

A007
Design Code: X14
Hayvanlı / Animals



A007
Design Code: X40
Peri / Fairy



OYUNCAK KUTUSU / ASKI VE KATLI BASAMAK TOYS BOX / CLOTHES HANGER AND DOUBLE STEP STOOL

ÜRÜN KODU PRODUCT CODE	ÜRÜN ADI / AÇIKLAMA PRODUCT NAME	KAPASİTE CAPACITY LT.	TEK ÜRÜN AĞIRLIĞI PRODUCT WEIGHT	KOLUÇ ADET PCS IN BOX	KOLU NET NET WEIGHT	KOLU BRÜT GROSS WL.	KOLU BOYUTU BOX DIMENSIONS (MM)	KOLU M ³ BOX M ³	PAKETLEME ŞEKLİ PACKING TYPE	BARKOD EAN 13 CODE
A007	Çocuk Elbise Askısı (6'ı) / Hangers For Child Clothes (6 pcs.)		0,147	240	5,88	6,18	475x255x345	0,042	BOX	869742230 183 3
SB006	Oyuncak Kutusu / Toys Box	20 Lt.	0,76	12	9,12	9,77	495x330x675	0,11	BOX	869742230 207 6
B003	Desenli Katlı Çocuk Basamağı / Go Go Child Double Step Stool		1040	12	12,48	12,48	400x370x740	0,11	BULK	869742230 254 0

/ Askılığı / Katlı Basamağı

/ Clothes Hanger/Double Step Stool



B003

Design Code: X79

Mavi-Trafik / Blue-Traffic



B003

Design Code: X78

Küçük Prenses / Little Princess

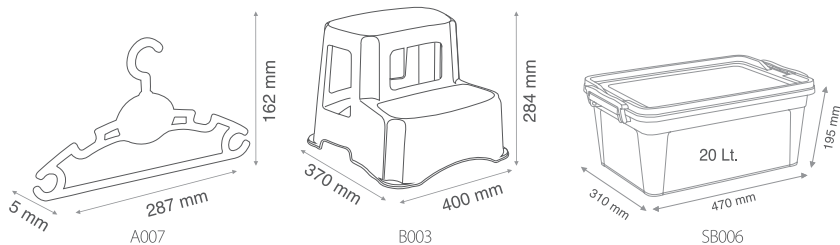



M016
Design Code: X80
Marin / Marine



M016
Design Code: X41
Arabalar / Cars



M016
Design Code: X15
Okyanus / Ocean



M016
Design Code: X14
Hayvanlı / Animals



M016
Design Code: X41
Prenses / Princess



M016
Design Code: X40
Peri / Fairy



M046
Design Code: X89
Şeffaf / Transparent



L019
Design Code: X16
Prenses / Princess



L019
Design Code: X41
Arabalar / Cars



L019
Design Code: X80
Marin / Marine



L019
Design Code: X15
Okyanus / Ocean



L019
Design Code: X14
Hayvanlı / Animals



L019
Design Code: X40
Peri / Fairy

ÇOCUK KOLTUKLARI VE LAZIMLIKLAR CHILD CHAIRS AND POTTIES

ÜRÜN KODU PRODUCT CODE	ÜRÜN ADI / AÇIKLAMA PRODUCT NAME	KAPASİTE CAPACITY LT.	TEK ÜRÜN AĞIRLIĞI PRODUCT WEIGHT	KOLİ ÇADET PCS IN BOX	KOLİ NET NET WEIGHT	KOLİ BRÜT GROSS WL	KOLİ BOYUTU BOX DIMENSIONS (MM)	KOLİ M ³ BOX M ³	PAKETLEME ŞEKLİ PACKING TYPE	BARKOD EAN 13 CODE
L019	Lazımlık / Potty (With Cover)		0,474	20	9,48	10,4	665x350x730	0,170	BOX	869742230 108 6
C031	Hasır Çocuk Koltuğu / Rattan Child Chair		0,606	25	15,15	15,15	360x340x1300	0,159	BULK	869742230 176 5
C032	Desenli Çocuk Koltuğu / Gogo Child Chair		0,612	25	15,3	15,3	360x340x1300	0,159	BULK	869742230 177 2
M016	Bebek Banyo Maşrapası / Baby Bath Pitcher	1,2Lt	0,086	72	6,192	6,54	430x275x445	0,053	POLY BAG	869742230 192 5
M046	Safir Bebek Banyo Maşrapası & Sapphire Baby Bath Pitcher	1,2Lt	0,086	72	6,192	6,54	430x275x445	0,053	POLY BAG	869742230 344 8

Koltukları ve Lazımlıklar

Chairs and Potties



C031
Design Code: X69
Mavi / Blue



C031
Design Code: X67
Sarı / Yellow



C031
Design Code: X68
Pembe / Pink



C031
Design Code: X24
Beyaz / White



C032
Design Code: X15
Okyanus / Ocean



C032
Design Code: X16
Prenseler / Princess



C032
Design Code: X14
Hayvanlı / Animals



C032
Design Code: X41
Arabalar / Cars



C032
Design Code: X40
Peri / Fairy

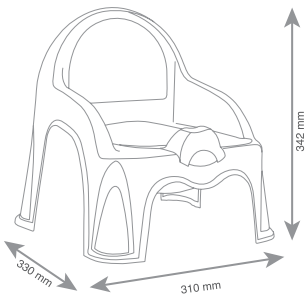

L019

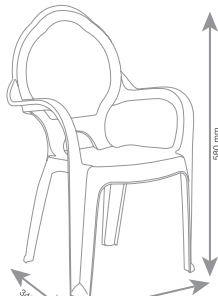

C031
C032

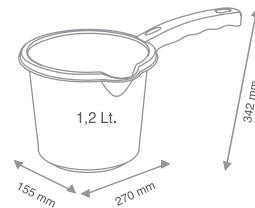

M016

Çocuk Komodinleri Child Commodes

83



K012
Design Code: X40
Peri / Fairy



K012
Design Code: X41
Arabalar / Cars



K012
Design Code: X80
Marin / Marine

DESENLİ ÇOCUK KOMİDİN GO GO COMMODE

ÜRÜN KODU PRODUCT CODE	ÜRÜN ADI / AÇIKLAMA PRODUCT NAME	KAPASİTE CAPACITY LT.	TEK ÜRÜN AĞIRLIĞI PRODUCT WEIGHT	KOLİ İÇİ ADET PCS IN BOX	KOLİ NET AĞIRLIĞI NET WEIGHT	KOLİ BRÜT AĞIRLIĞI GROSS W.	KOLİ BOYUTU BOX DIMENSIONS (MM)	KOLİ M ³ BOX M ³	PAKETLEME ŞEKLİ PACKING TYPE	BARKOD EAN 13 CODE
K012	Desenli Çocuk Komodin / Go Go Commode		4,87	1	4,87	5,03	39,5x42x41	0,069	SHRINK	869742230 347 9



 OZERplastik  ozerplastik



ÖZ-ER PLASTİK SAN. VE TİC. LTD. ŞTİ.

Merkez / Head Office:

İstoç 11. Ada No: 18-20 Bağcılar - İstanbul / Türkiye

Tel: +90 212 659 00 32 **Fax:** +90 212 659 16 20

info@ozerplastik.com

Fabrika & İhracat Showroom Departmanı / Factory & Export Showroom Department:

Çakmaklı Akçaburgaz Mah. Akçaburgaz Cad. No: 54 Esenyurt - İstanbul / Türkiye

Tel: +90 212 886 94 94 **Fax:** +90 212 886 94 96

export@ozerplastik.com

Katalogdaki resimler ÖZ-ER Plastik San. Tic. Ltd. Şti.'ne aittir. İzinsiz kullanılamaz.
Tipografik hatalardan firmamız sorumlu değildir.

www.ozerplastik.com